

SCORE Bucks County

What a GREAT Idea!

But Is it a GREAT Business???

**An Overview Of The Score One-Page Business Plan
And The Business Model Canvas**

Shameless Plug: Bucks County SCORE mentors
are ready to assist you in using these tools!

Your Moderator Today



Before and After Teaching



A GREAT IDEA!

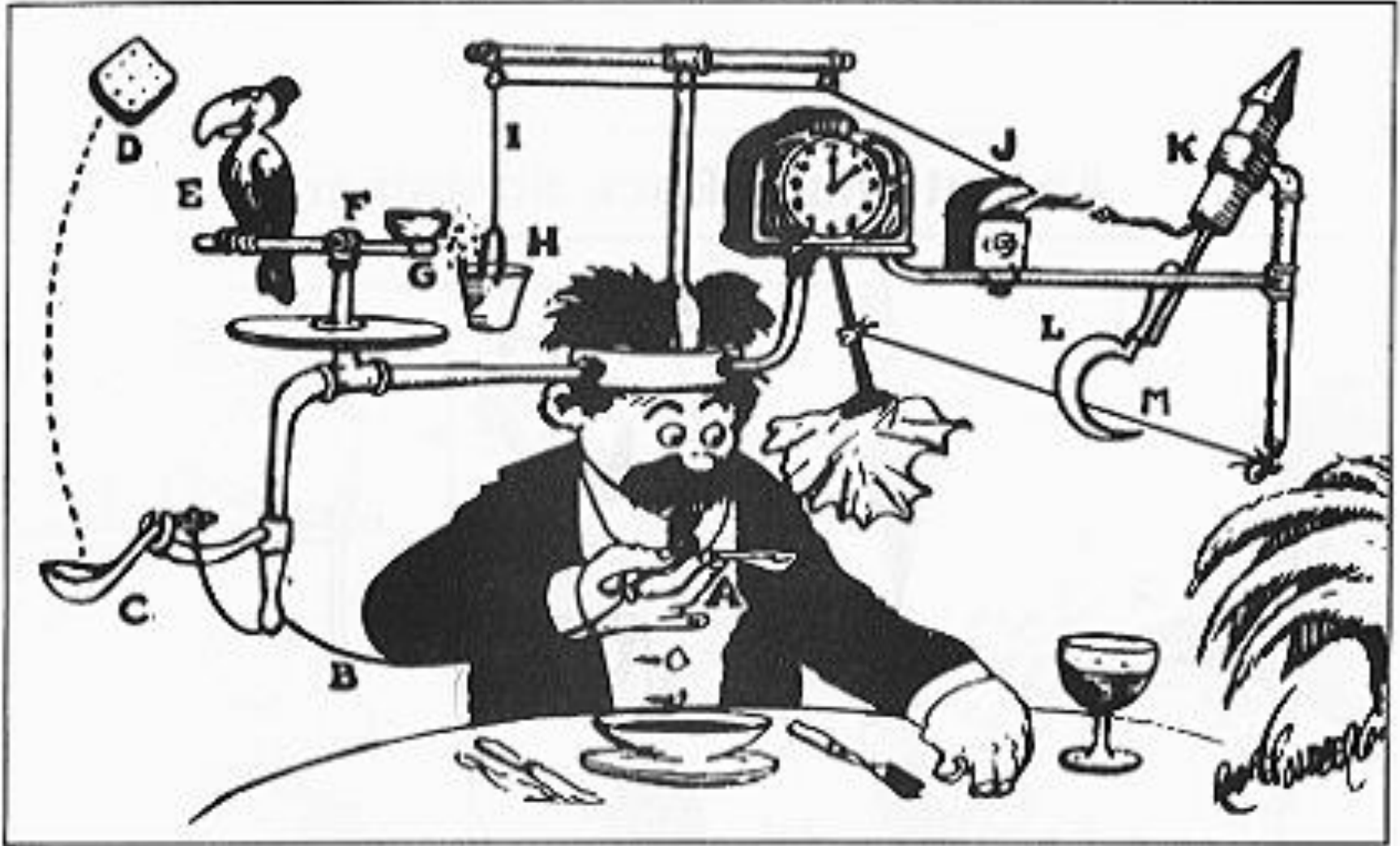

On the Other Hand

UNTUCKit

**An Idea Nobody Believed
in Led to 8 Million Shirts
and 88 Stores for a Retail
Phenomenon**



Business Idea Vs Business



One-Page Business Plan
Business Model
Canvas

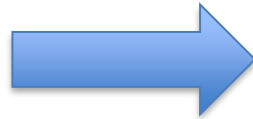

Full Business Plan

IDENTITY

OPBP-1

Describe your business in one sentence. What do you do and who do you do it for? For example, a bike shop's identity might be: "We offer high-quality biking gear for families and regular people, not just gearheads."

Your identity is what sets you apart from the competition. It's how you define who you are as a business.

PROBLEM WORTH SOLVING

Describe the problems that your potential customers have. Why do they need your products or services?

OUR SOLUTION

What is your product or service? Describe it here and how it solves your customer's problem.

TARGET MARKET

Who are your customers? Describe your ideal customer here and, if you know, how many of them there are.

THE COMPETITION

What other products and services do your potential customers use today to solve their problems? How are you better than the competition?

SALES CHANNELS

Describe how you will sell to your customers. Will you sell directly to them at a storefront or with a website? Will you use a sales team or distributors? Describe your sales process here.

MARKETING ACTIVITIES

What are the primary ways you will reach your customers? If you will be advertising or using PR, describe those activities here.

REVENUE

What are your primary revenue streams? Don't worry about listing specific revenue goals when you are early in the process. Instead, describe how you will make money and what products or services will generate that revenue.

EXPENSES

List your major expenses here. There's no need to go into a lot of detail in the early stages. Just list the areas that you expect to spend the most money on.

MILESTONES

List your primary goals and objectives that you hope to achieve over the next few months. What do you need to get done to take your business from idea to reality?

TEAM AND KEY ROLES

If you have business partners or need to hire key people to help you launch the business, list those people and positions here.

PARTNERS AND RESOURCES

Some businesses need key partners in order to launch. Other businesses may have intellectual property or other resources that will help them get up and running. List those partners and resources here.

The Business Model Canvas

HOW

WHAT

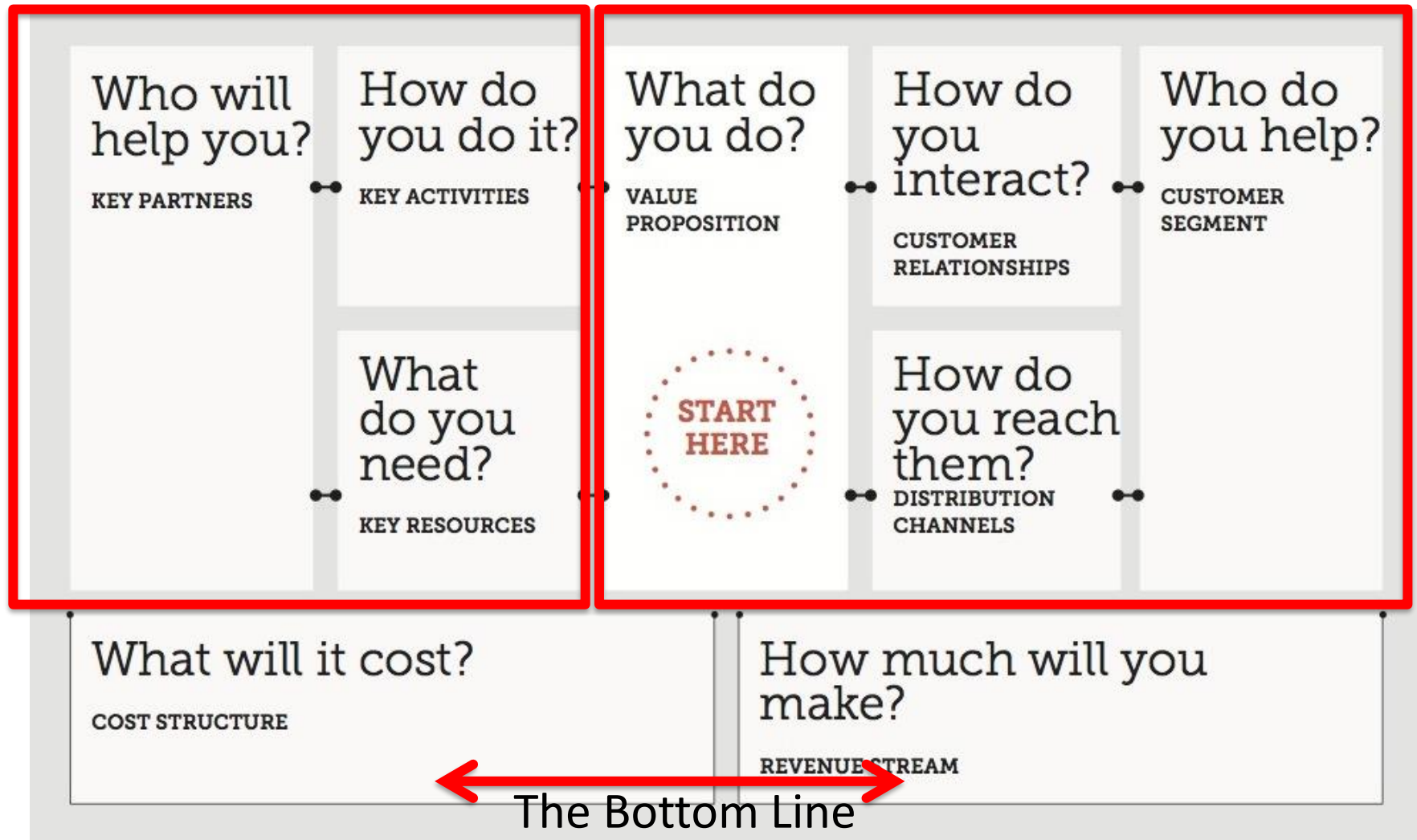

Value and Issues of the BMC

Benefits

- Tools
- Get out of the building
- One-Page Summary

BUT

- You think that you are done

Value and Issues of the OPBP

Benefits

- Adds to analysis elements
- One-Page Summary

And

- You are less likely to think that you are done

OPBP - IDENTITY – Why Are You Here?

Describe your business in one sentence. What do you do and who do you do it for? For example, a bike shop's identity might be: "We offer high-quality biking gear for families and regular people, not just gearheads."

Your identity is what sets you apart from the competition. It's how you define who you are as a business.

Customer Segments

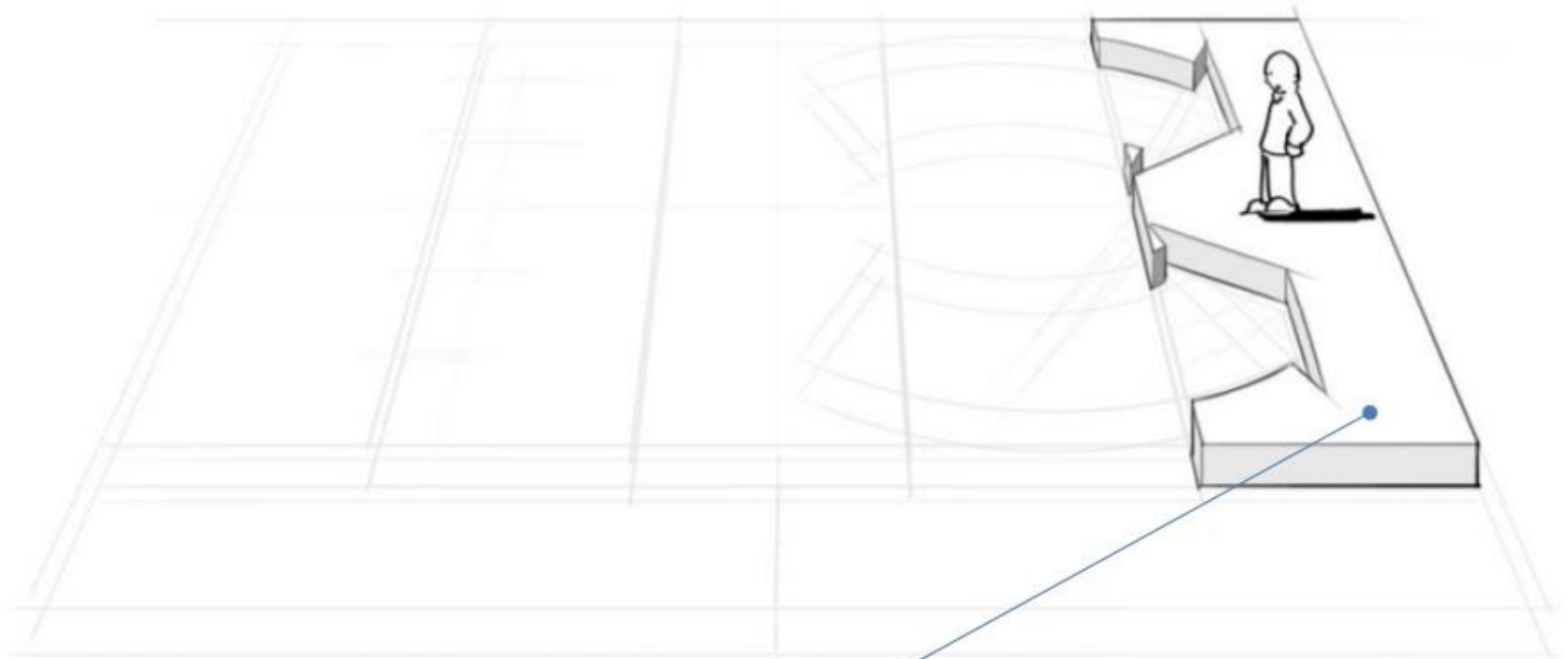

which customers and users are you serving?
which jobs do they really want to get done?

drawings by JAM

Value Proposition

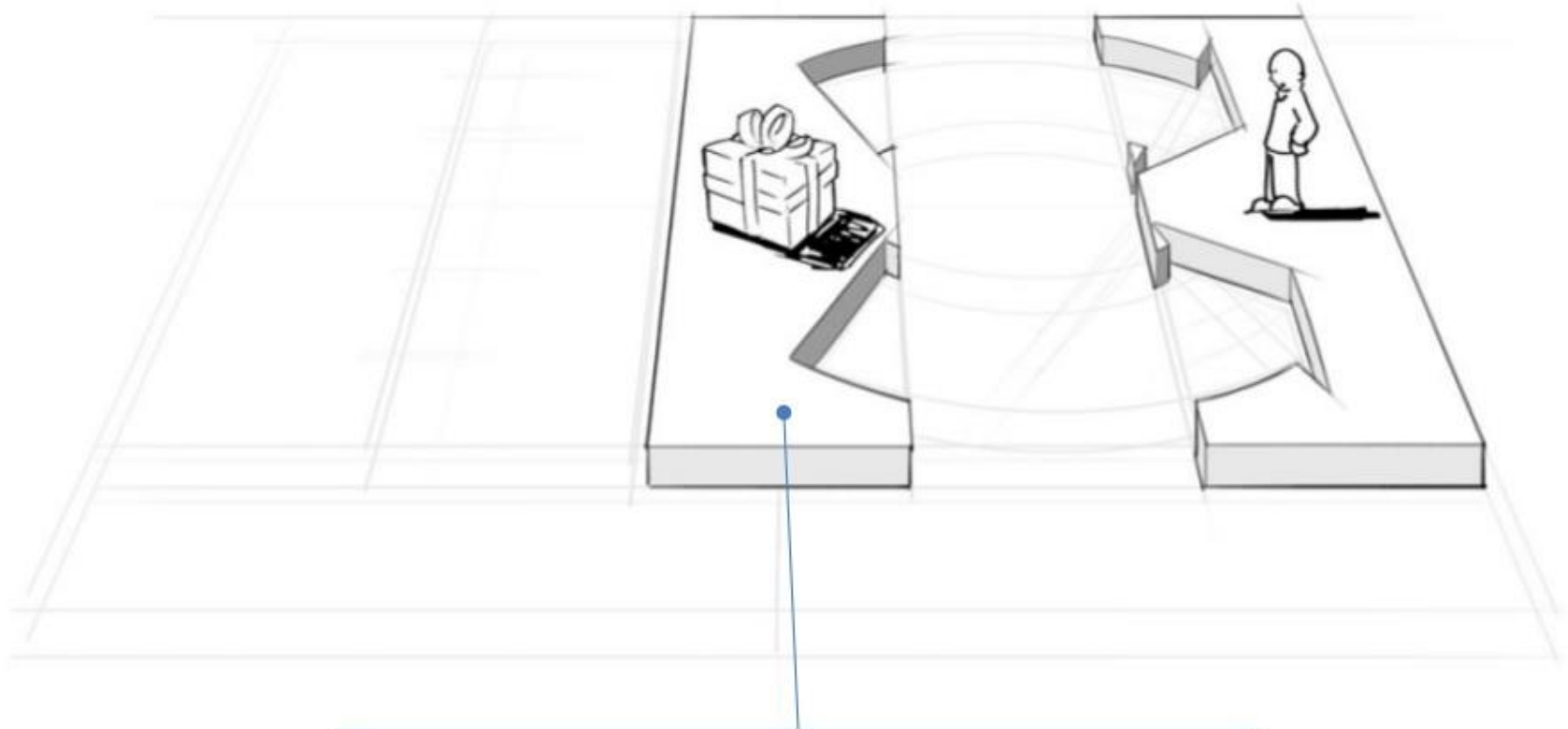

what are you offering them? what is that getting done for them? do they care?

drawings by JAM

Value Proposition

Key Concept :

**Minimum Viable Product
(MVP)**

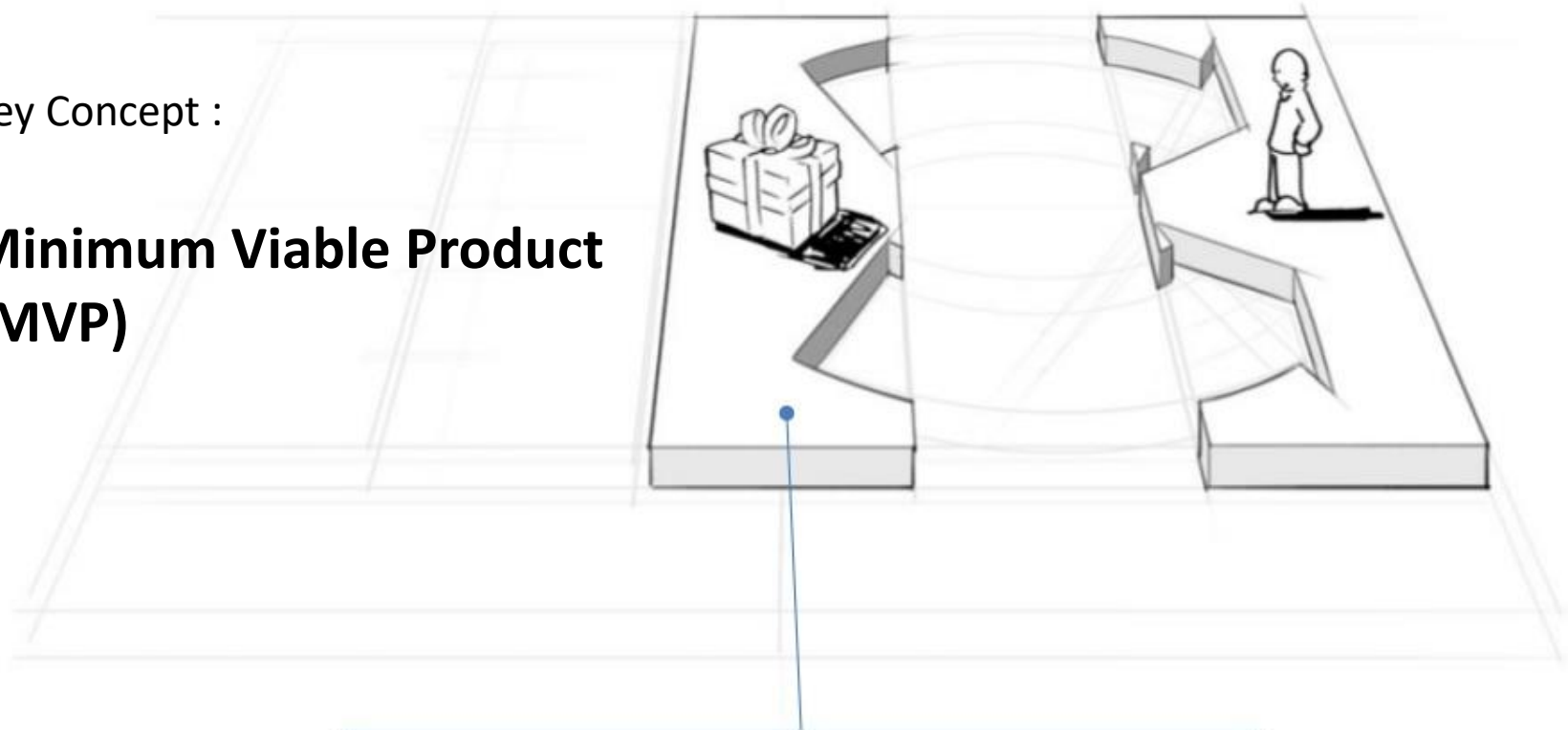

what are you offering them? what is that getting done for them? do they care?

drawings by JAM

How to Answer the Questions

1. Write down what you think
2. Then
 - Find some possible customers
 - Ask them
 - Refine and repeat
3. Which answers matter?

Customer Segments

Key Concepts:

- **Customer Personas**
- **A day in the life**

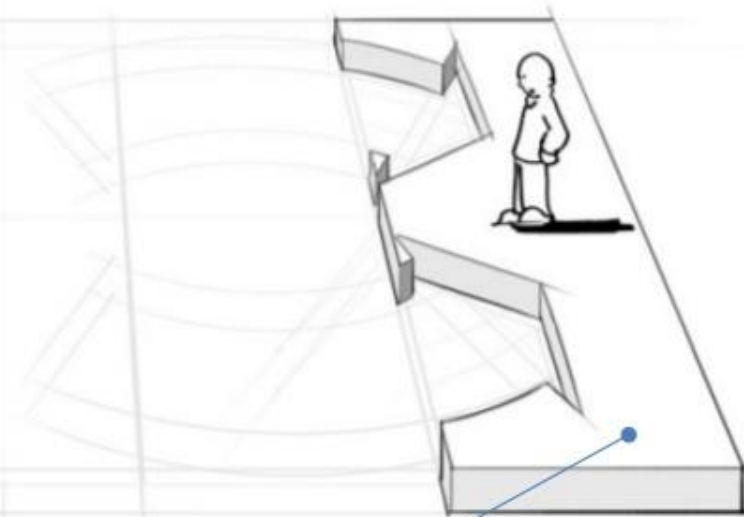

which customers and users are you serving?
which jobs do they really want to get done?

drawings by JAM

Channels

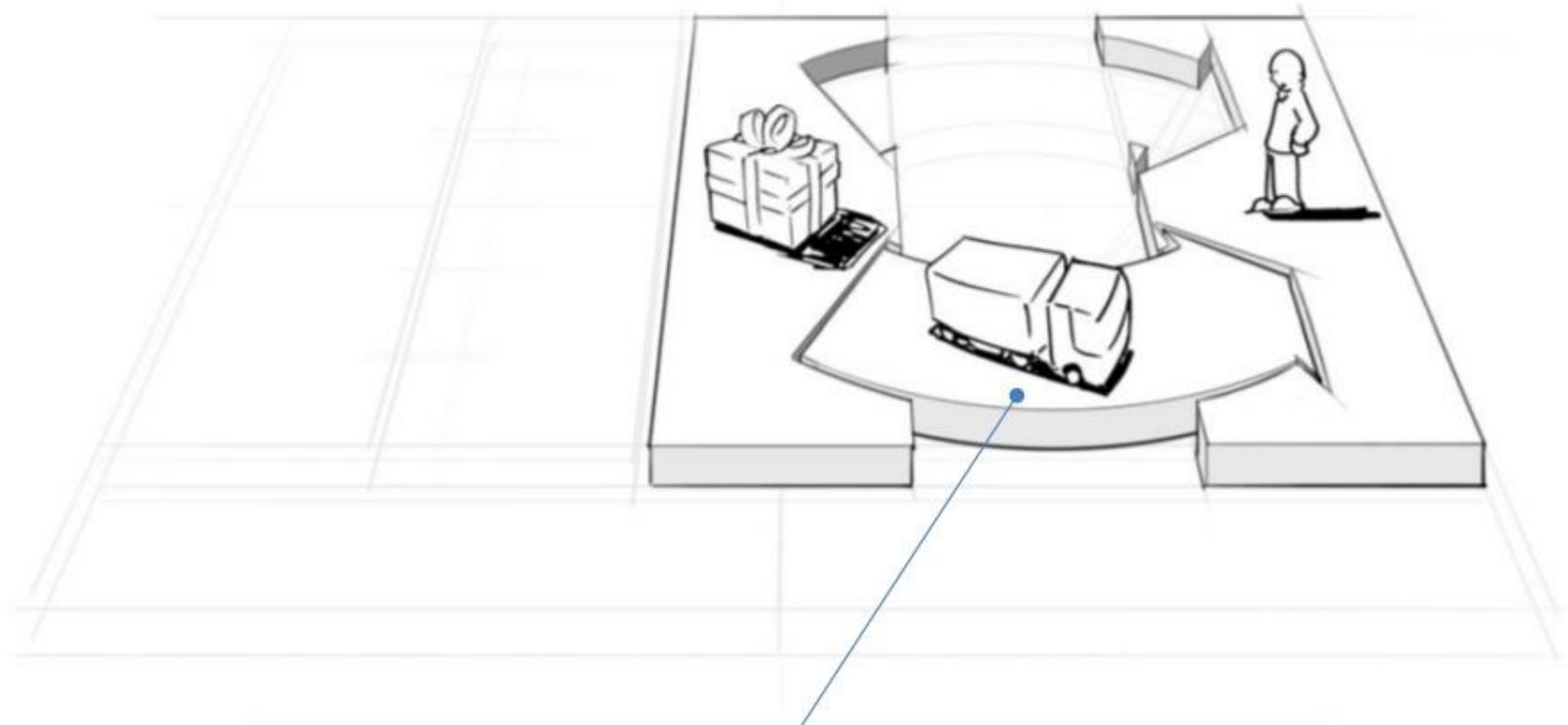

how does each customer segment want to be reached?
through which interaction points?

drawings by JAM

Channels

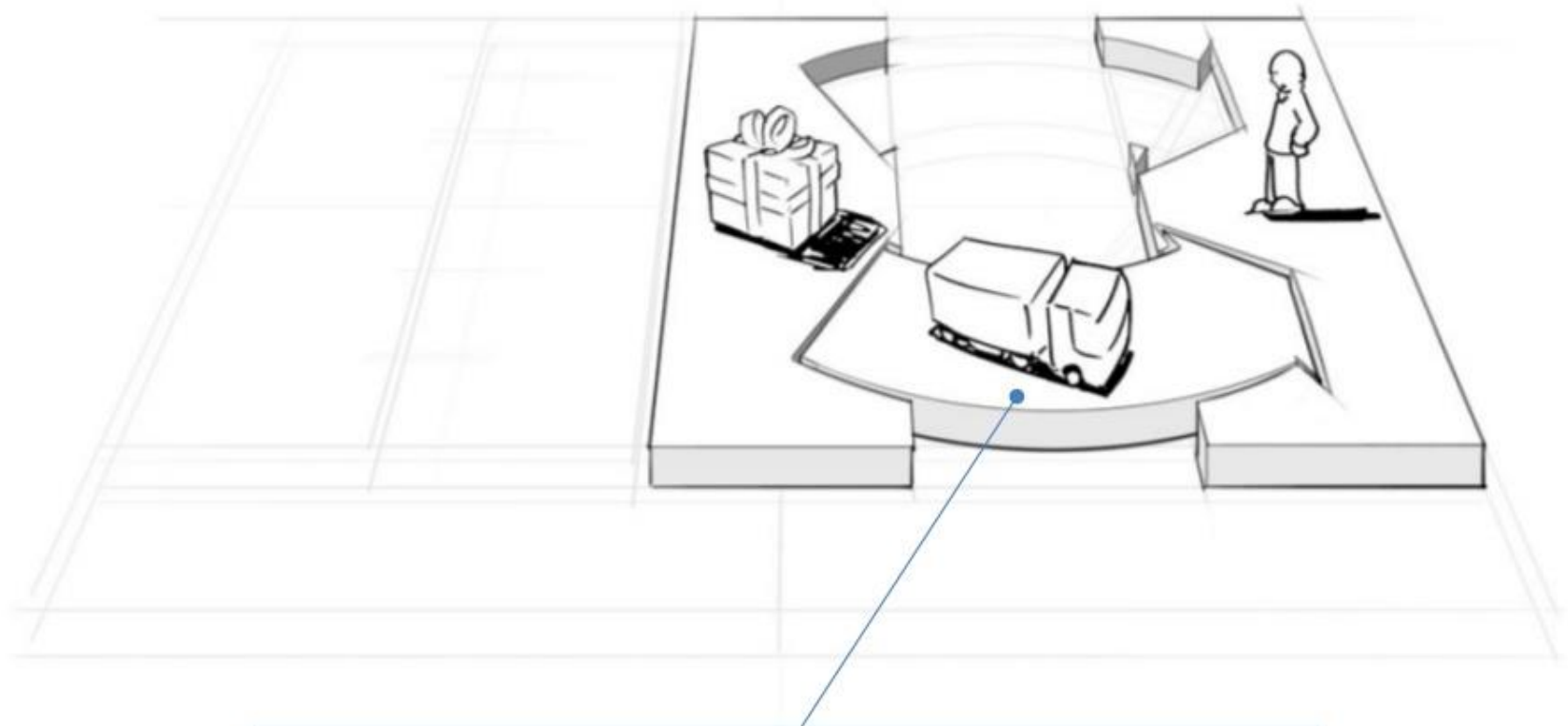

how does each customer segment want to be reached?
through which interaction points?

drawings by JAM

Channels

Key Concepts:

- **Touch points**
- **Customer experience**

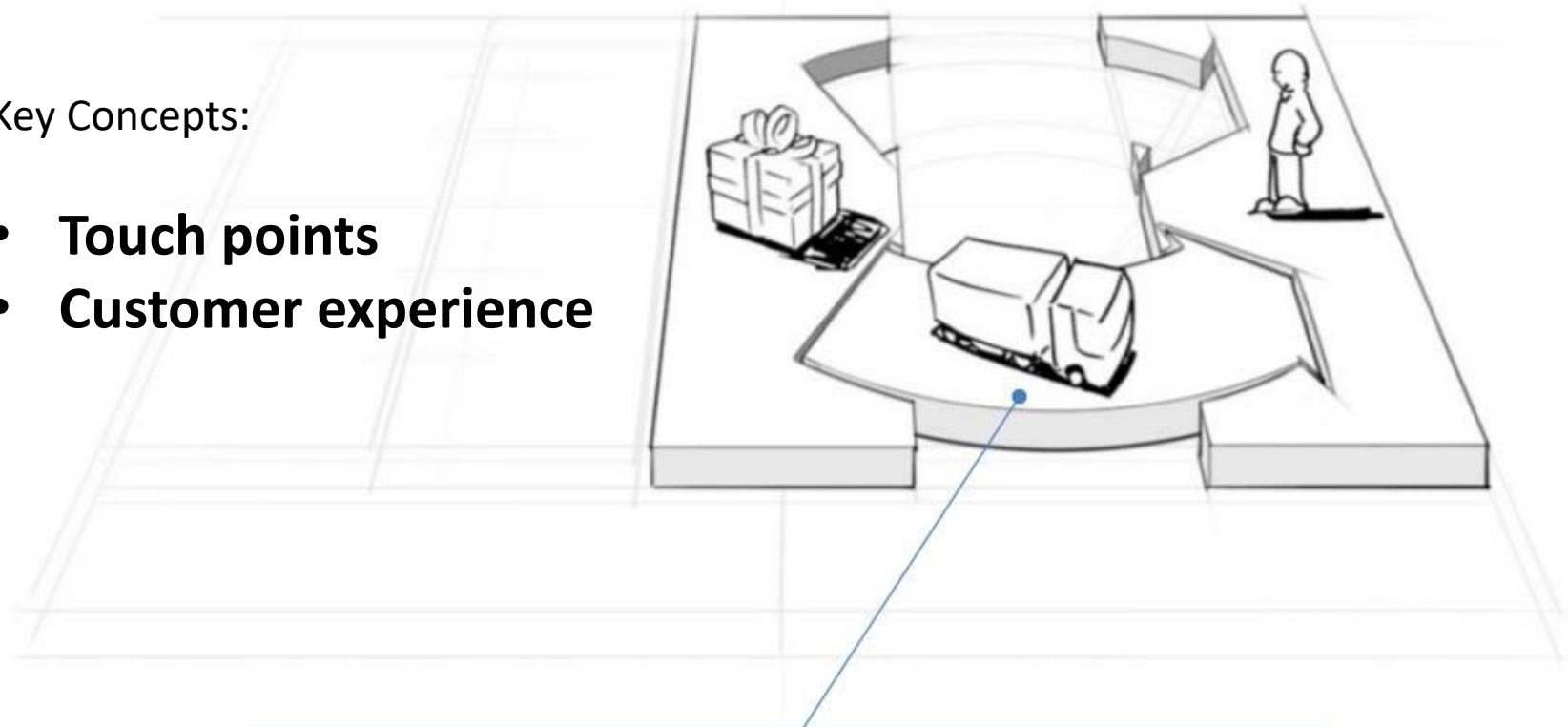

how does each customer segment want to be reached?
through which interaction points?

drawings by JAM

Customer Relationships

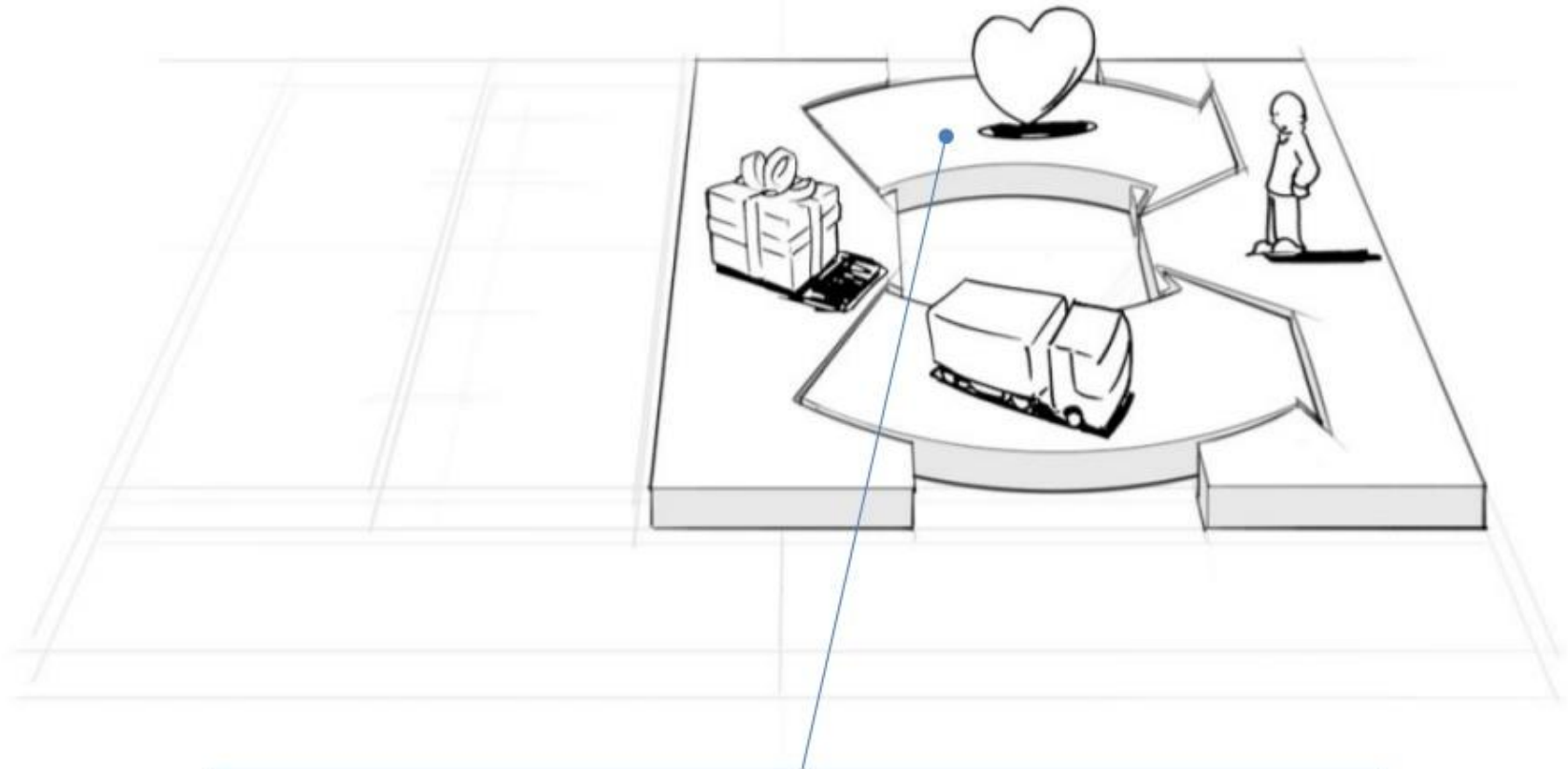

what relationships are you establishing with each segment?
personal? automated? acquisitive? retentive?

drawings by JAM

Customer Relationships

Key Concepts:

Get
Keep
Grow

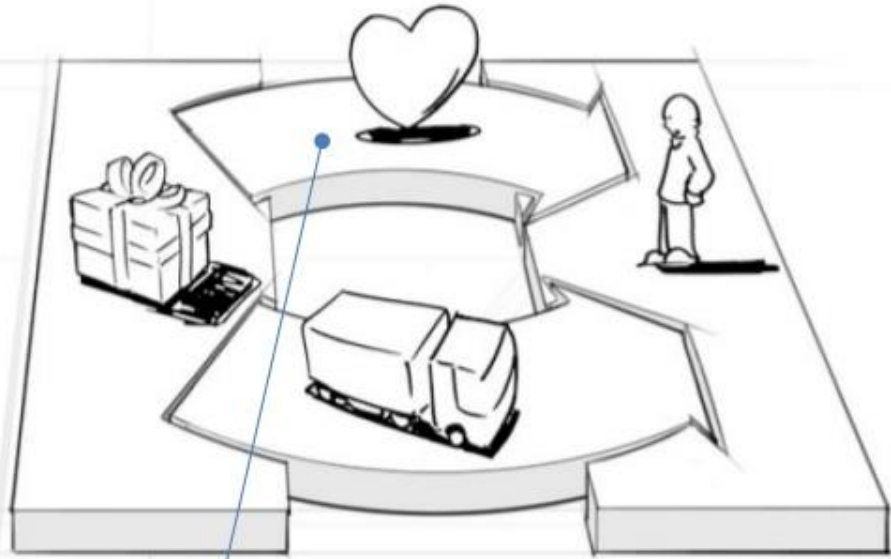

what relationships are you establishing with each segment?
personal? automated? acquisitive? retentive?

drawings by JAM

Revenue Streams

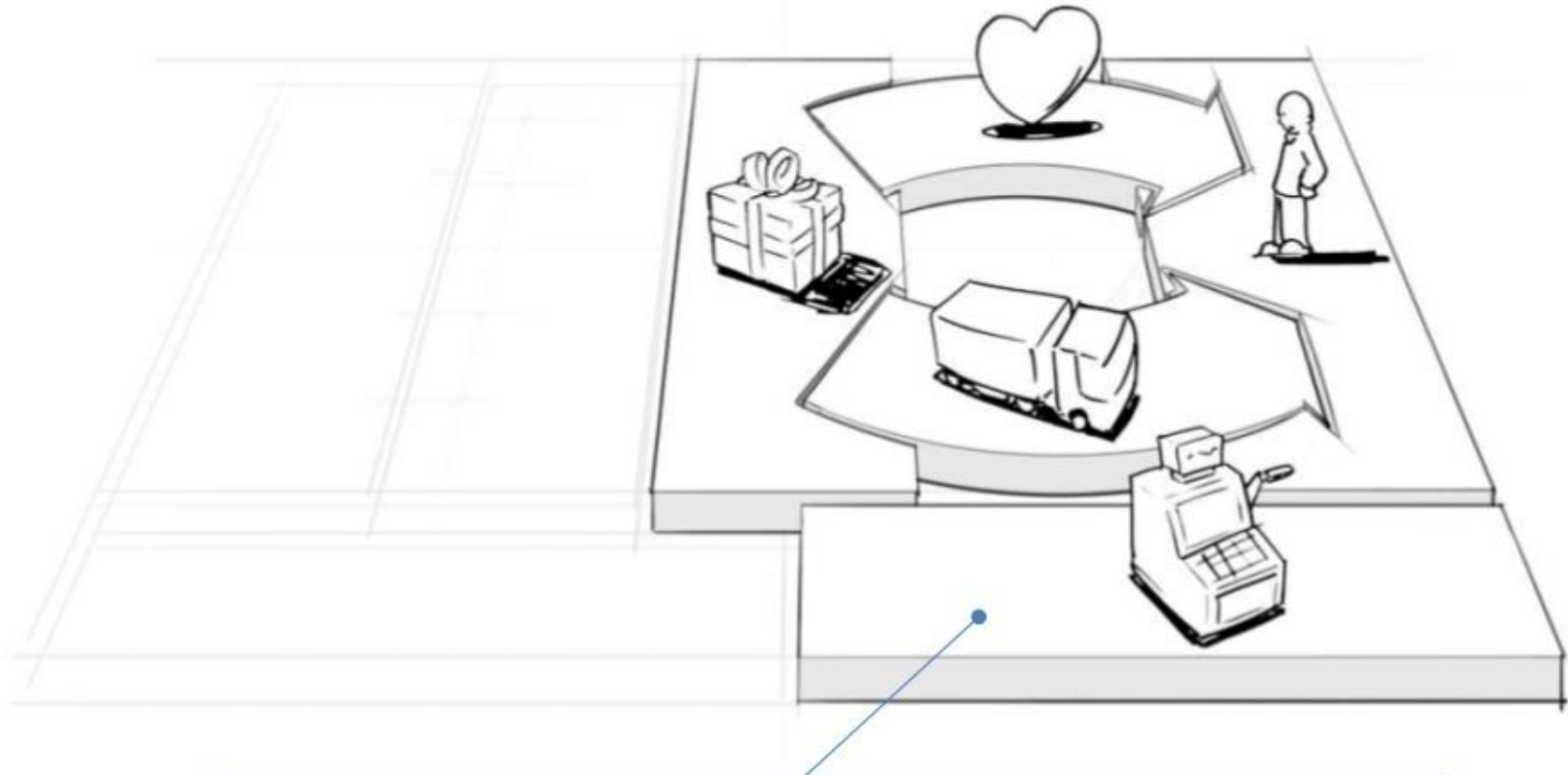

what are customers really willing to pay for? how?
are you generating transactional or recurring revenues?

drawings by JAM

Key Resources

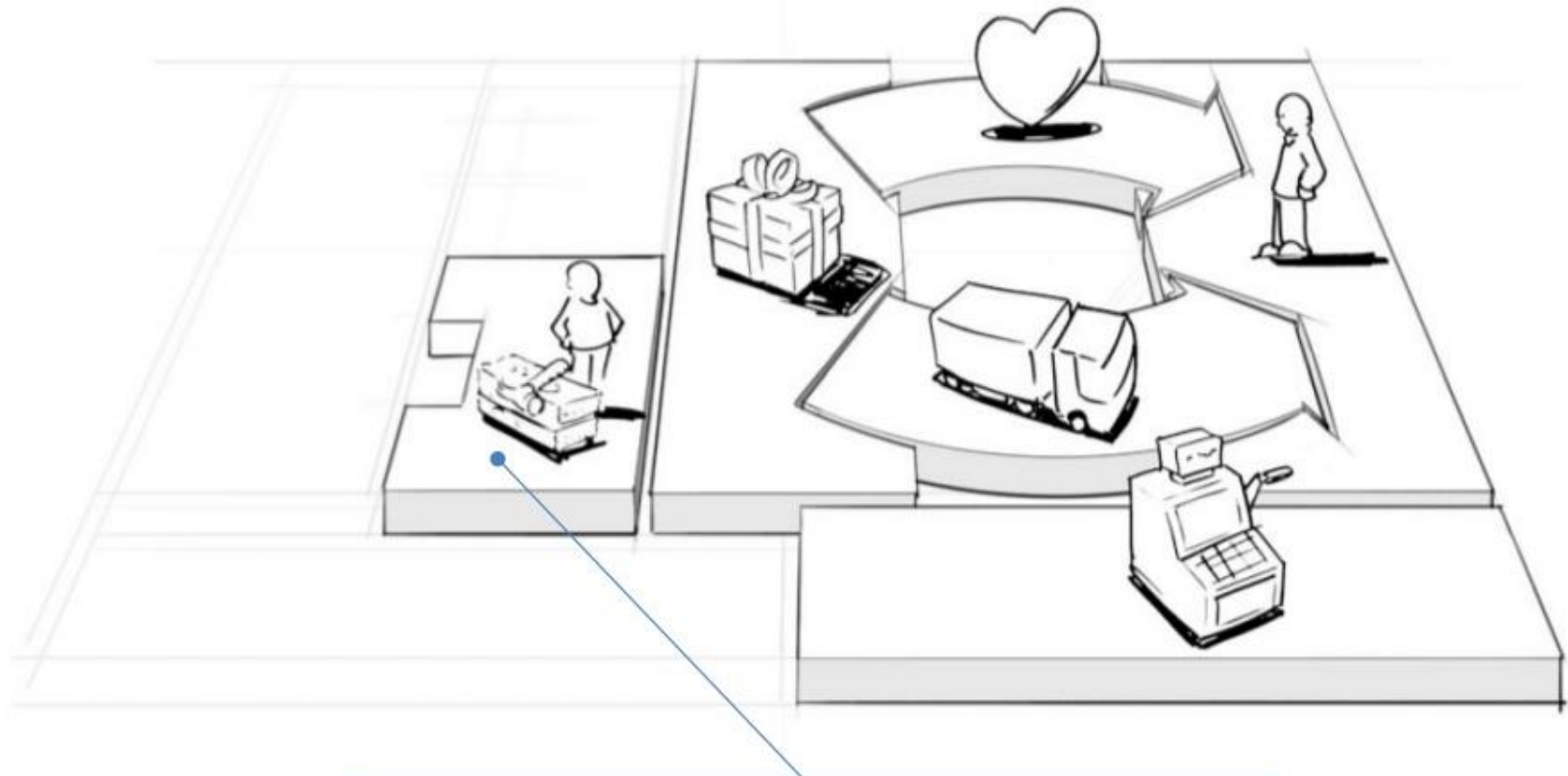

which resources underpin your business model?
which assets are essential?

drawings by JAM

Key Activities

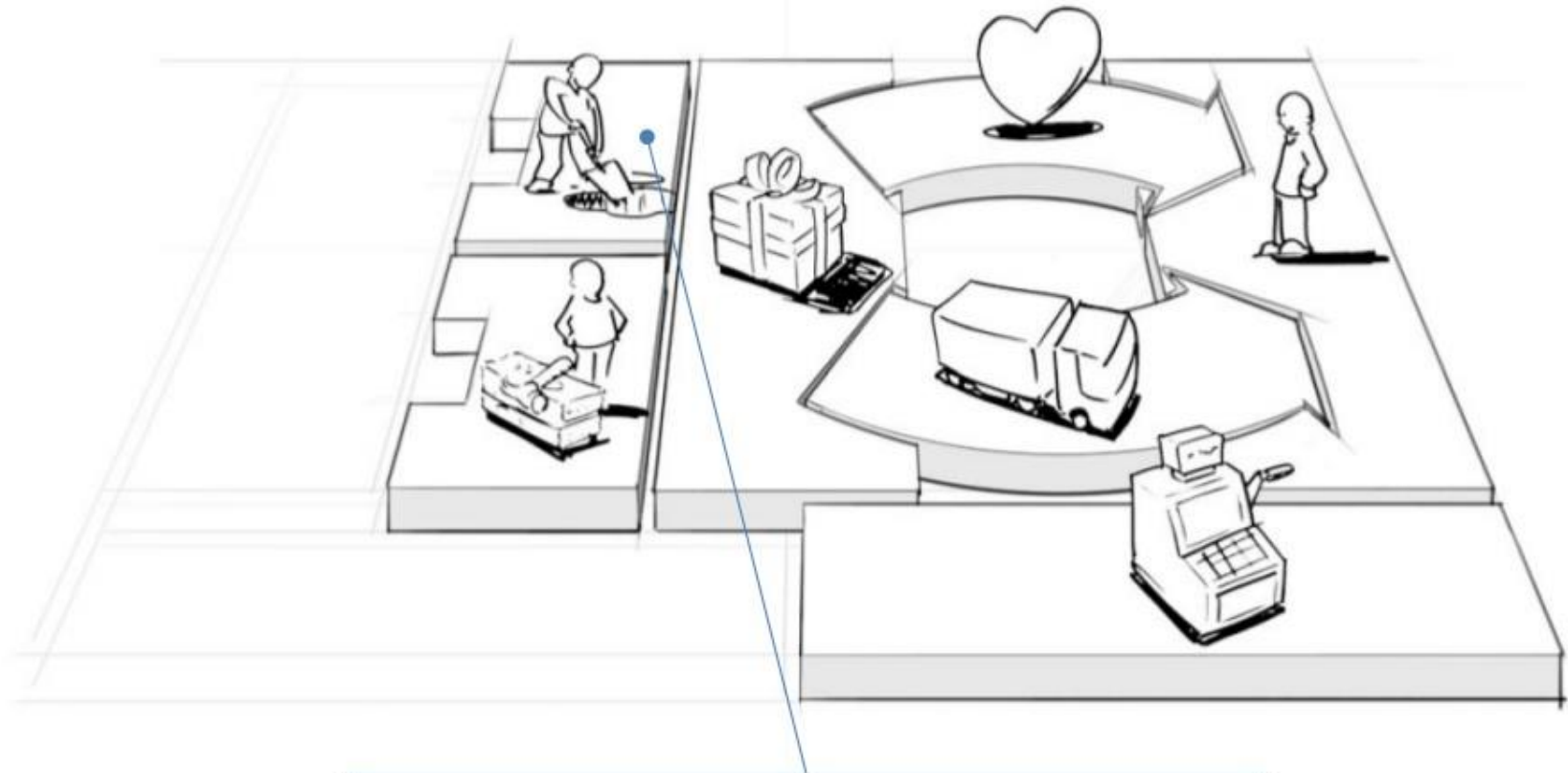

which activities do you need to perform well in your business model? what is crucial?

drawings by JAM

Key Partners

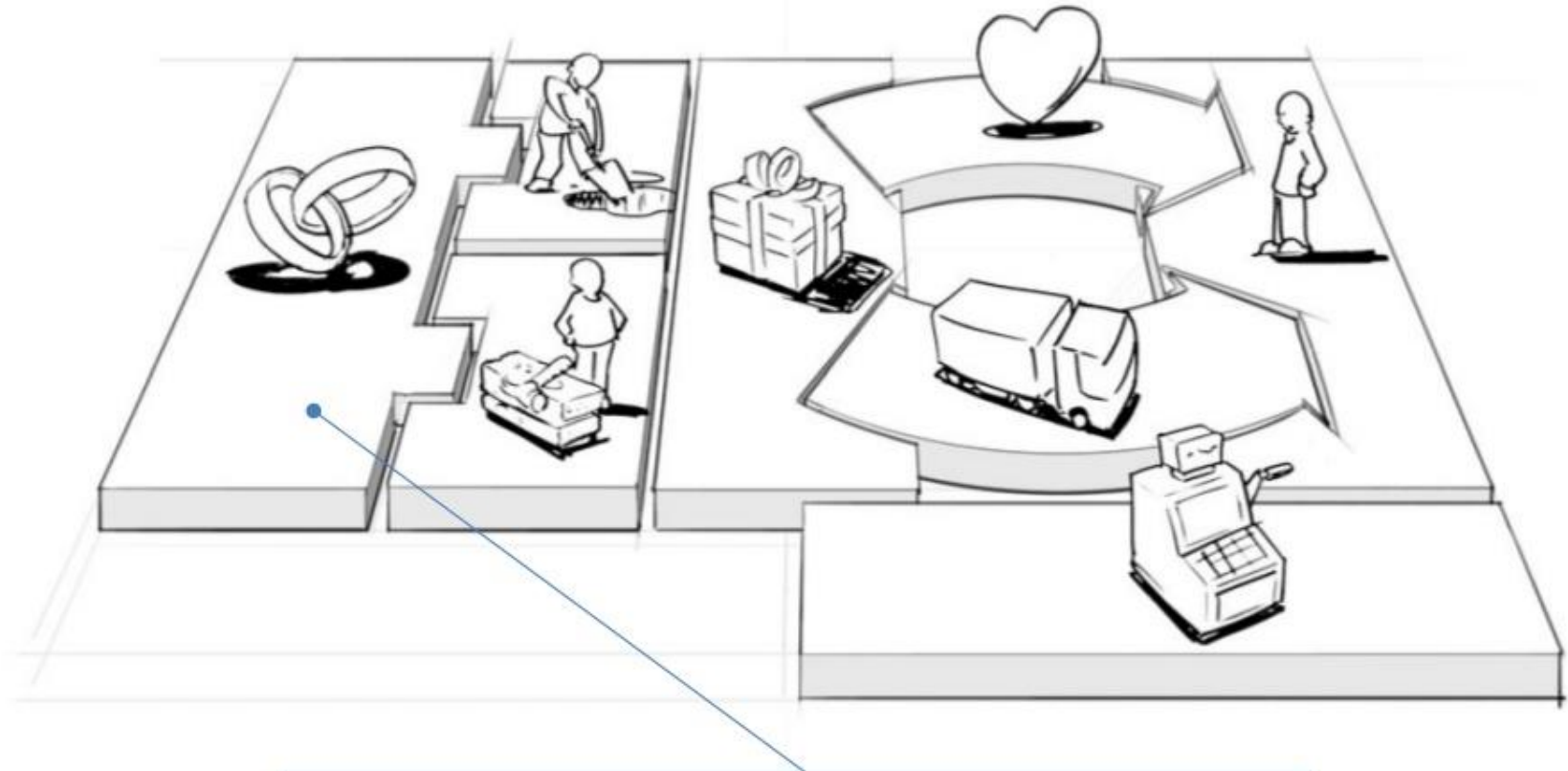

which partners and suppliers leverage your model?
who do you need to rely on?

drawings by JAM

Cost Structure

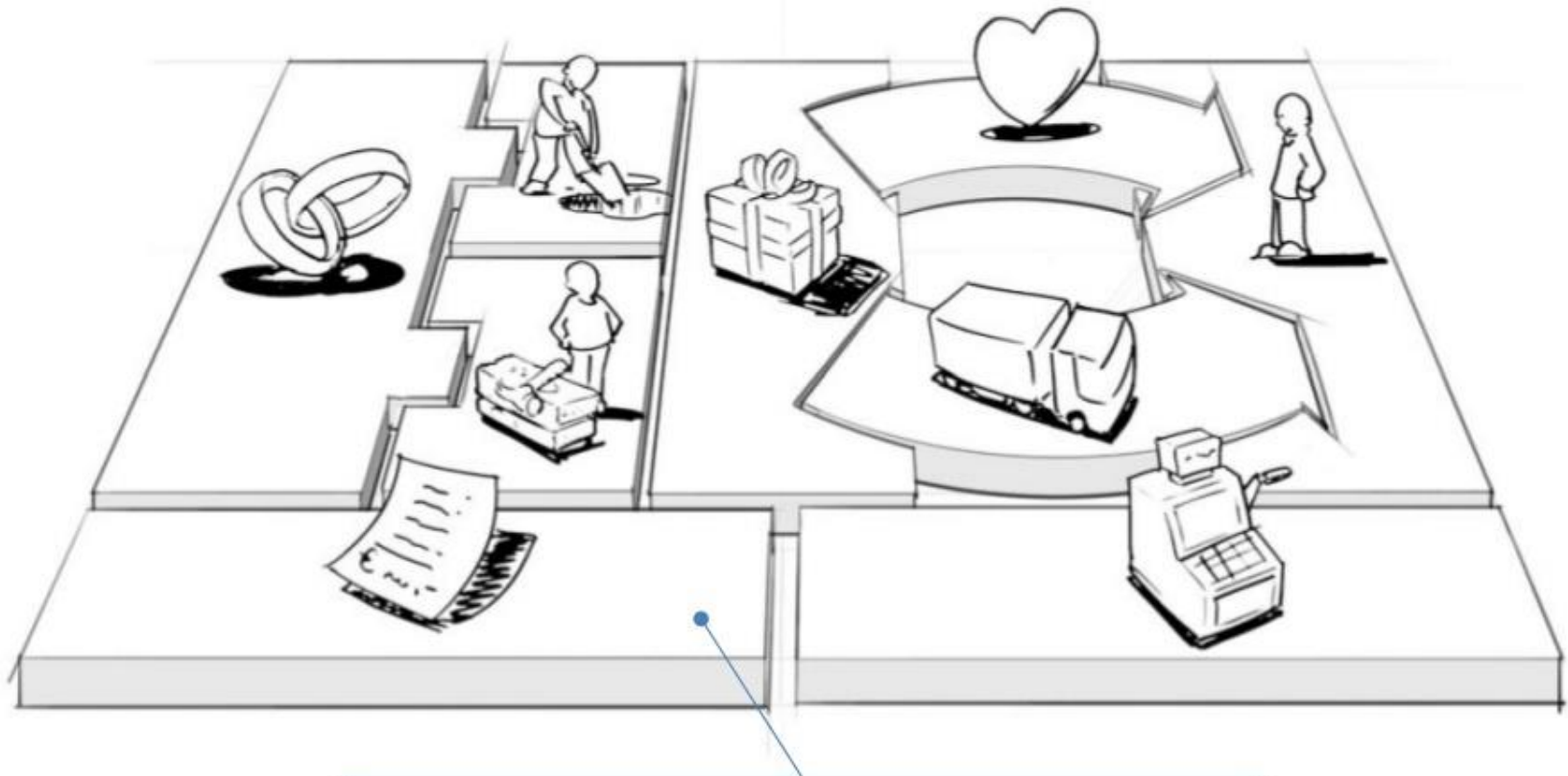

what is the resulting cost structure?
which key elements drive your costs?

drawings by JAM

Business Model Canvas

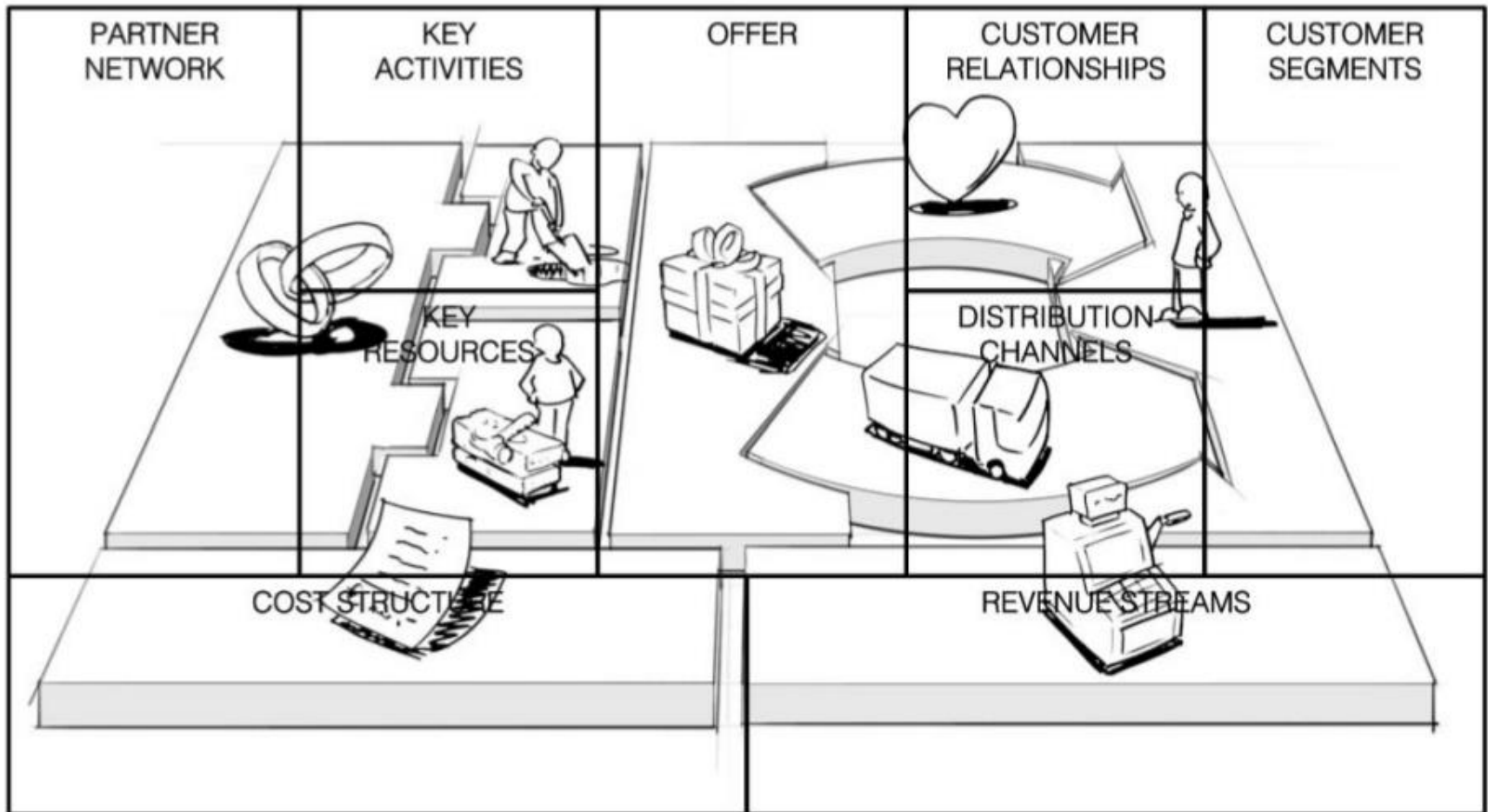

drawings by JAM

Use of BMC and OPBP - IT'S NOT LINEAR

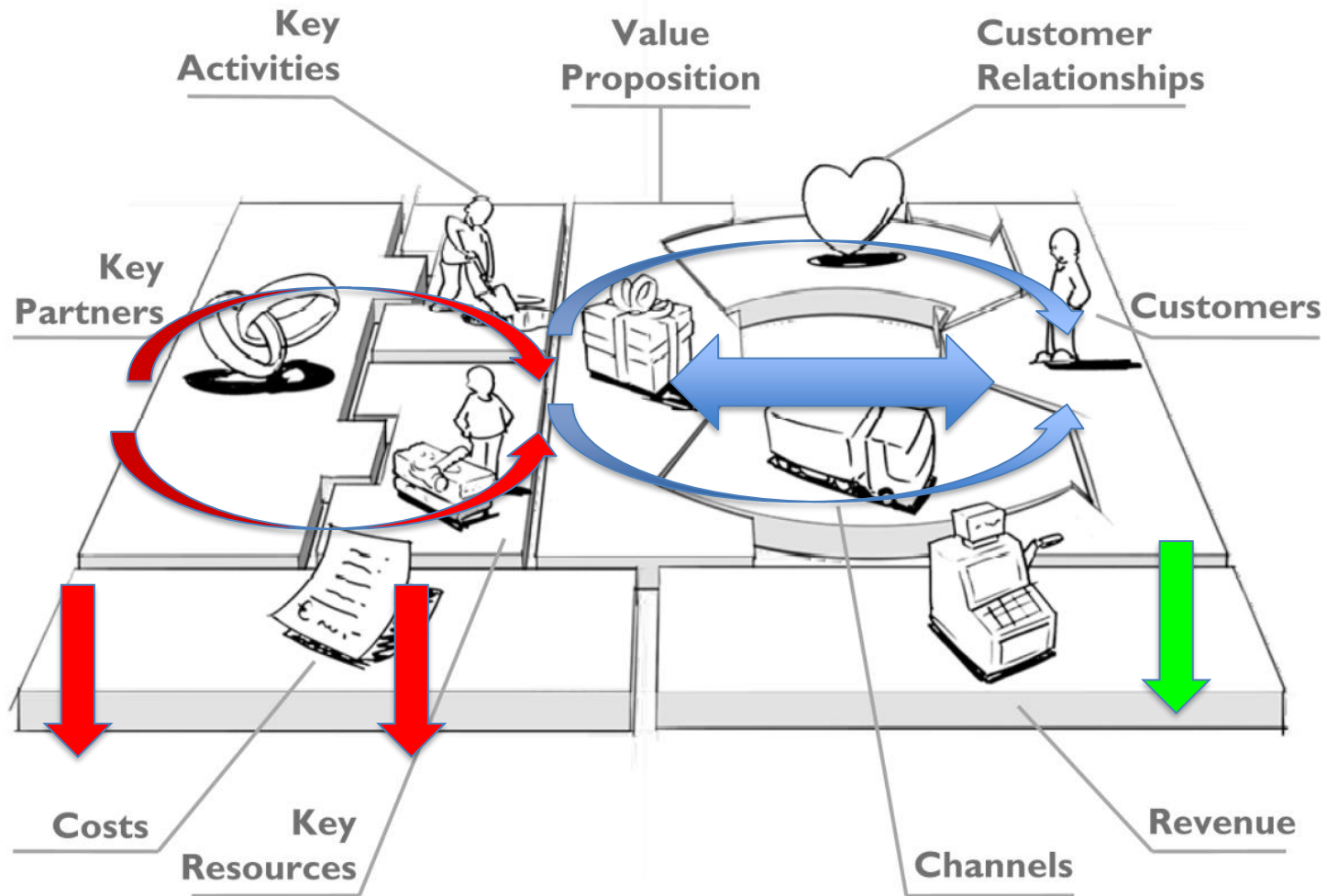

drawings by JAM

Why we value our own ideas so highly



The IKEA effect

- You put it together
- Congrats
- You own it

Key to success

**GET
OUT
OF
THE
BUILDING!**

The Value Proposition Canvas

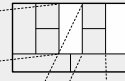

Value Proposition

Customer Segment

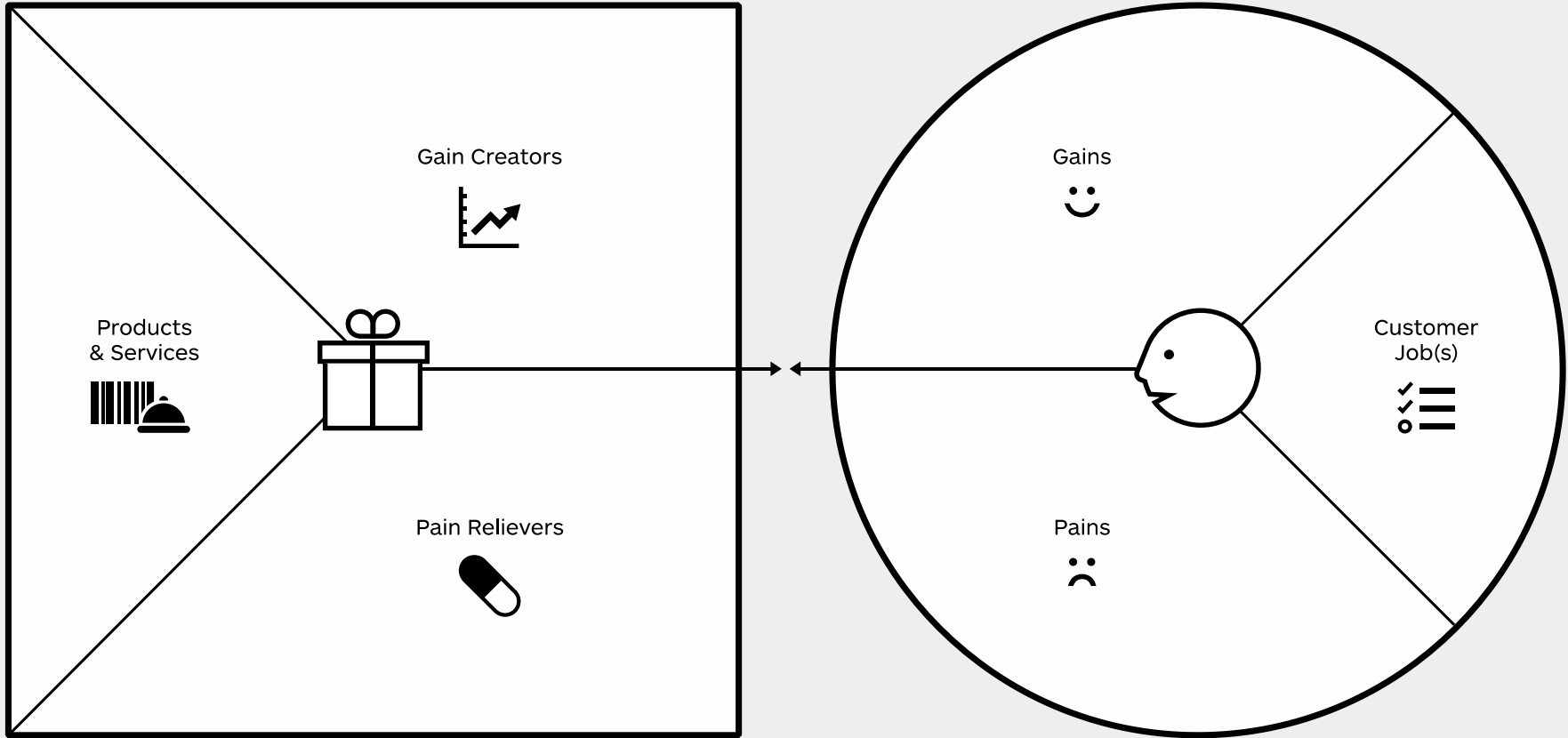

COPYRIGHT: Strategyzer AG
The makers of Business Model Generation and Strategyzer

Strategyzer
strategyzer.com

Value Proposition Canvas

Product

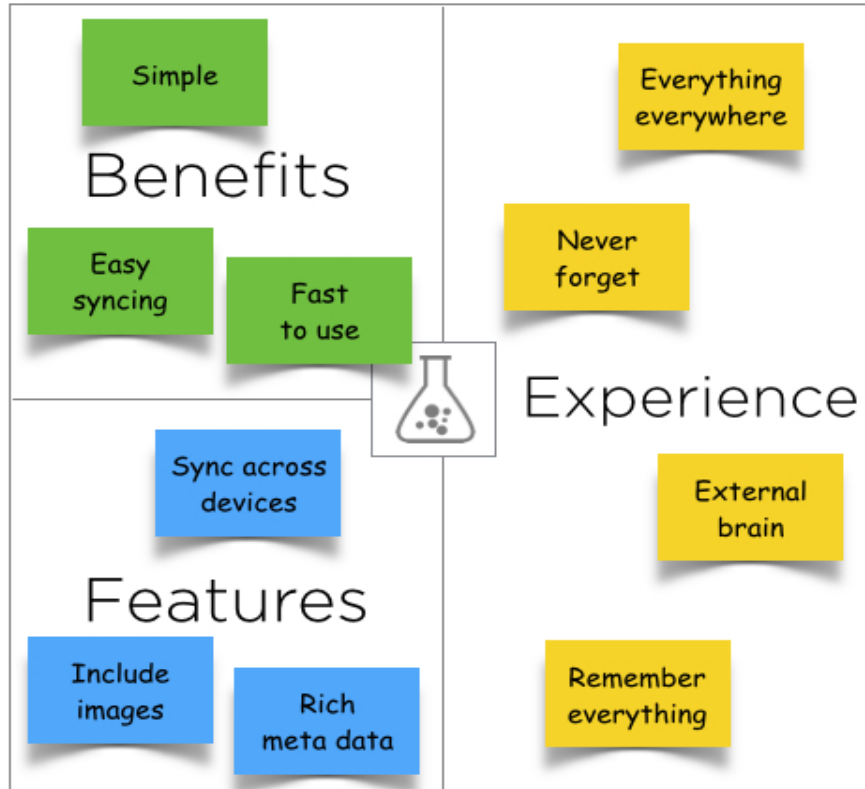

Company: **Evernote**
 Product: **Online notes**
 Ideal customer: **Mobile professionals**

Customer

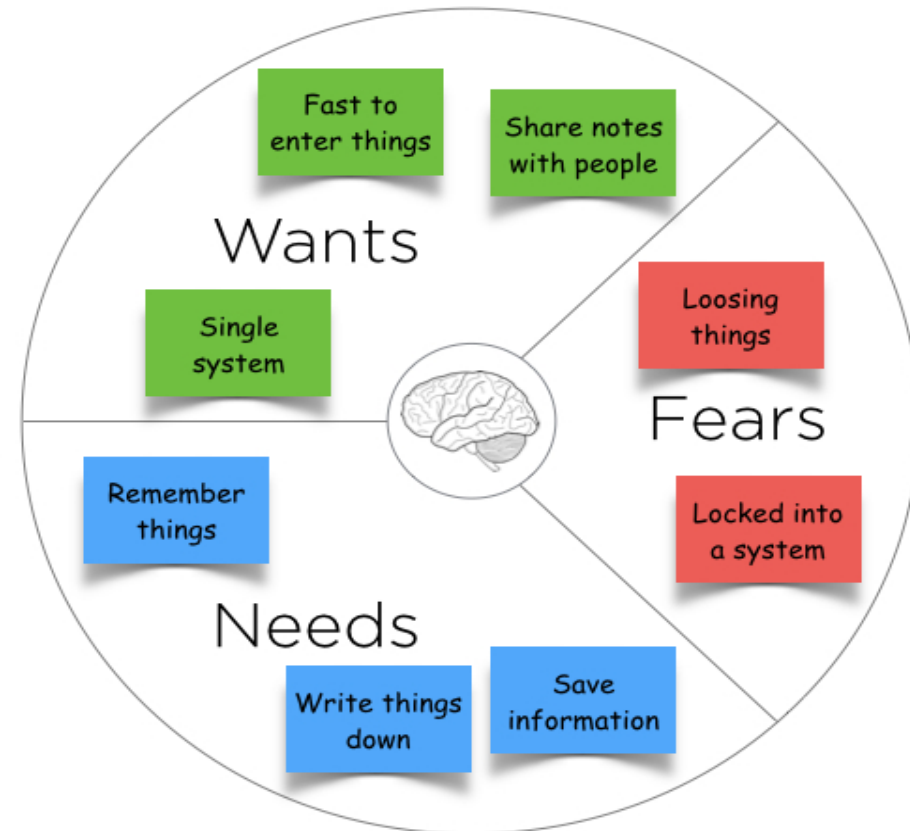

Substitutes

- Email to yourself
- Text documents

Based on the work of Steve Blank, Clayton Christensen, Seth Godin, Yves Pigneur and Alex Osterwalder. Released under creative commons license to encourage adaption and iteration. No rights asserted.

SUMMARY – What the OPBP and BMC Don't Do

- The OPBP and the BMC are NOT Business Plans
- They do NOT replace a Business Plan
- They are NOT a shortcut – it still takes work and time and testing – and thinking
- They are NOT useful in seeking funding

SUMMARY – What the OPBP & BMC DOES

They provide:

- Structure of a business plan without the overhead,
- The improvisation of a ‘back of the napkin” sketch without the fuzziness (and coffee rings).

They are **MOST USEFUL** in the search for a viable business model for a startup, a growth initiative, and a diagnostic tool.

Advantages:

- **Focus**
- **Flexibility**
- **Transparency:**

RESOURCES

- Bucks County Score Mentors – copies and guidance for the OPBF
- Search on the term “Business Model Canvas” for images
- Search on Slideshare for slide decks
- Books “Business Model Generation” “The Lean Startup”
- Free course on Udacity
www.udacity.com/course/how-to-build-a-startup--ep245
- Email me – don.goeltz@scorevolunteer.org

The slides today are cheerfully borrowed from

- www.Strategizer.com
- www.alexandercowan.com/business-model-canvas-templates/
- <https://www.slideshare.net/esaife/business-model-canvas-101>
- <http://www.marketingespresso.net/groupon-bm/>
- https://hbr.org/resources/images/article_assets/2013/10/canvas1.gif

Summary Chart with Questions

<p>KEY PARTNERS</p> <p>Who are our key partners? Who are our key suppliers? Which key resources are we acquiring from our partners? Which key activities do partners perform?</p>	<p>KEY ACTIVITIES</p> <p>What key activities do our value propositions require? Our distribution channels? Customer relationships? Revenue streams?</p>	<p>VALUE PROPOSITIONS</p> <p>What value do we deliver to the customer? Which one of our customers' problems are we helping to solve? What bundles of products and services are we offering to each segment? Which customer needs are we satisfying? What is the minimum viable product?</p>	<p>CUSTOMER RELATIONSHIPS</p> <p>How do we get, keep, and grow customers? Which customer relationships have we established? How are they integrated with the rest of our business model? How costly are they?</p>	<p>CUSTOMER SEGMENTS</p> <p>For whom are we creating value? Who are our most important customers? What are the customer archetypes?</p>
<p>COST STRUCTURE</p> <p>What are the most important costs inherent to our business model? Which key resources are most expensive? Which key activities are most expensive?</p>	<p>KEY RESOURCES</p> <p>What key resources do our value propositions require? Our distribution channels? Customer relationships? Revenue streams?</p>		<p>CHANNELS</p> <p>Through which channels do our customer segments want to be reached? How do other companies reach them now? Which ones work best? Which ones are most cost-efficient? How are we integrating them with customer routines?</p>	
	<p>COST STRUCTURE</p> <p>What are the most important costs inherent to our business model? Which key resources are most expensive? Which key activities are most expensive?</p>		<p>REVENUE STREAMS</p> <p>For what value are our customers really willing to pay? For what do they currently pay? What is the revenue model? What are the pricing tactics?</p>	

The OPBP and BMC

QUESTIONS?

Thank YOU - Back To My Strategy Class

