



Business Launch Pad

How to Start a Business



Entrepreneurial Myths & Realities

- All I need is a good idea to be a successful entrepreneur.
- “I’m good at this. I should start a business!”
- If you build it, they will come.
- If you go out on your own, you won’t have to work so hard or such long hours.
- You’ll be able to deduct everything, so you don’t have to pay taxes.



Entrepreneurial Myths & Realities

- You don't have to report to a boss.
- The customer is always right.
- We're good friends. We'll work well together.
- Profit is all that matters in business.
- Failure is bad.



My
Son!

What Percent of Businesses Fail?

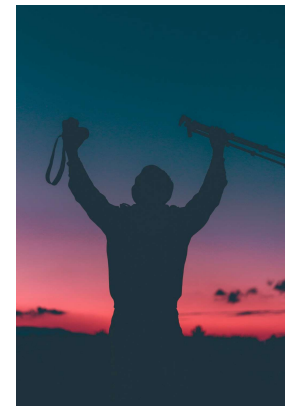
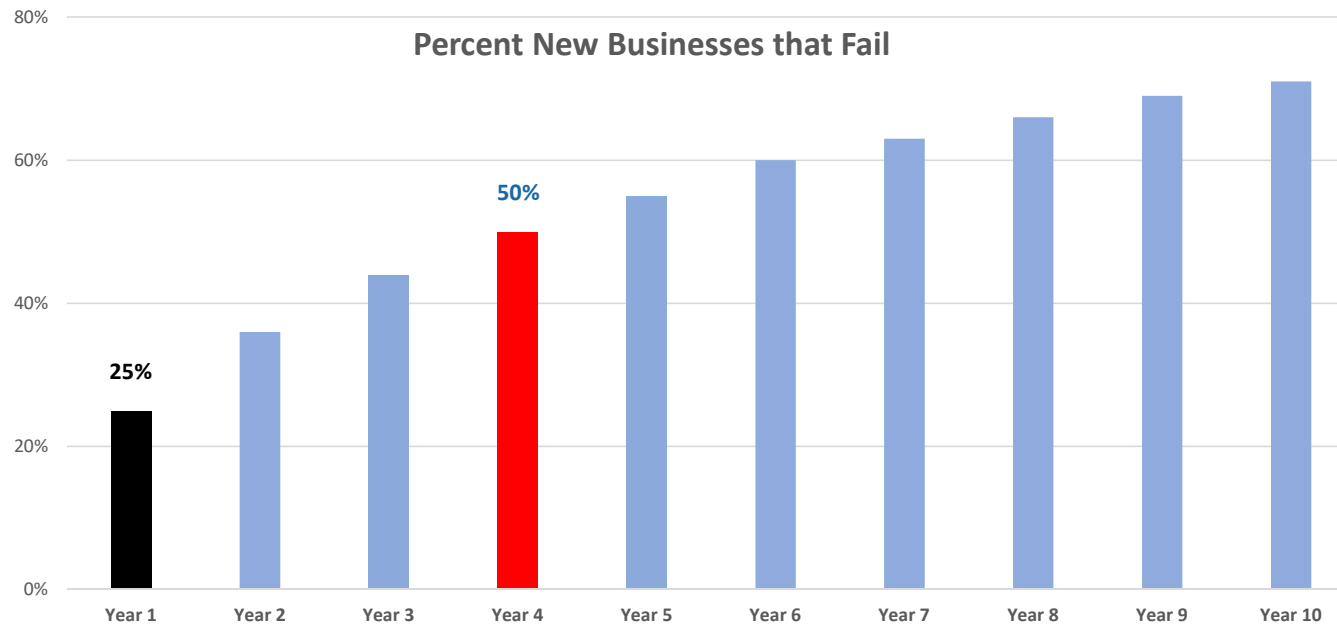

Photo by [Diego PH](#) on [Unsplash](#)

Top 10 Reasons Why Businesses Fail

1. Poor management/leadership
2. Inadequate, ill-timed, poorly-tracked finances
3. Lack of a written Business Plan
4. Choosing a business that is not very profitable
5. Failure to monitor ongoing operations and results
6. Failure to properly price products or services
7. Failure to anticipate or react to competition, technology or changes in the marketplace
8. Ineffective marketing, including your website
9. Poor execution
10. Believing you can do it all yourself



SCORE Bucks County

Start a Business Workshop

An overview of
THE BUSINESS MODEL CANVAS

Shameless Plug: Bucks County SCORE mentors
are ready to assist you in using this tool!

Business Model Vs Business Plan



Business Model
Canvas



Business Plan

What are we talking about?

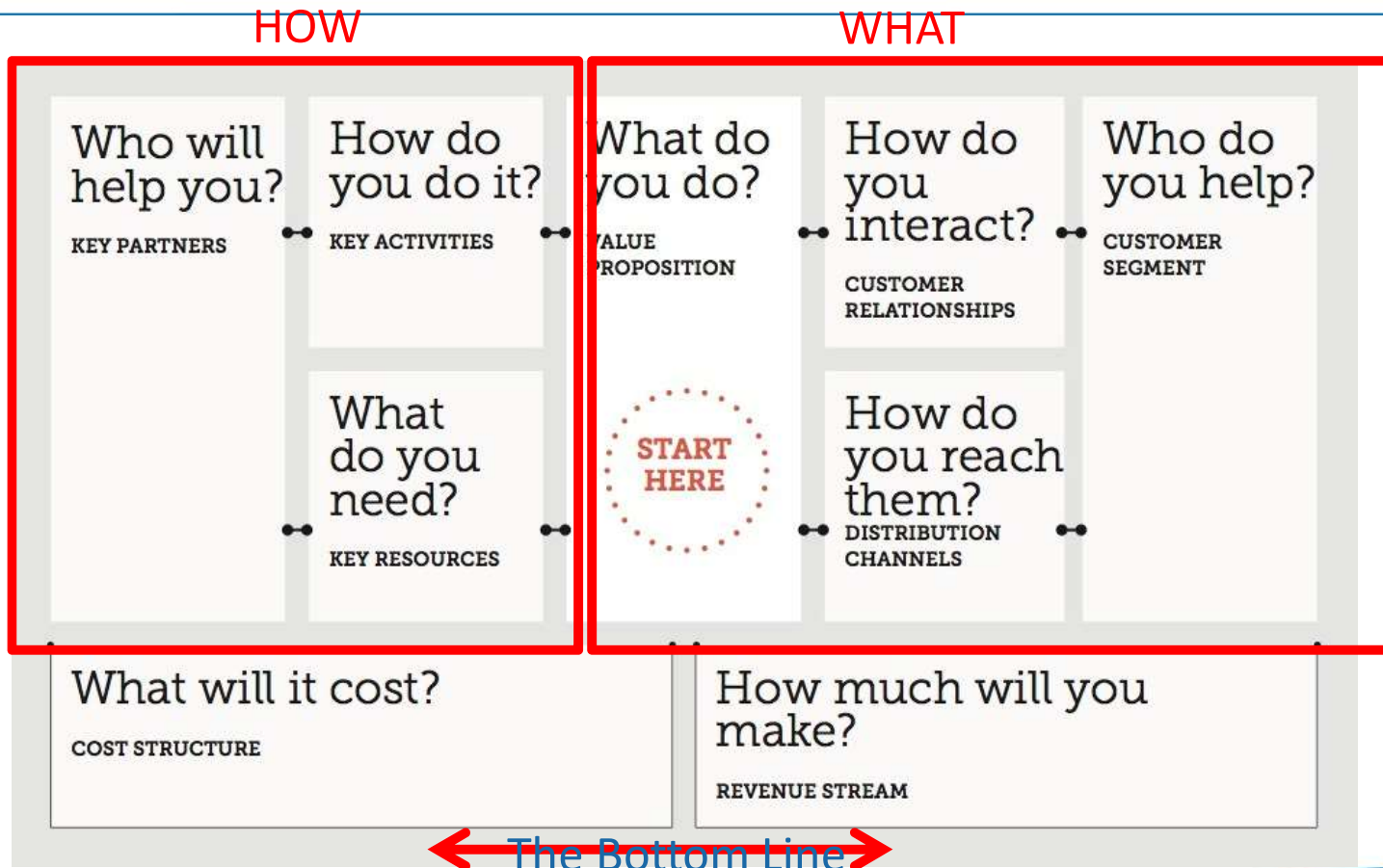

business model ?

“A business model describes the rationale of how an organization **creates, delivers, and captures** value”

The Business Model Canvas is a
tool to create & analyze
business models...



7

9 building blocks

9

Customer Segments

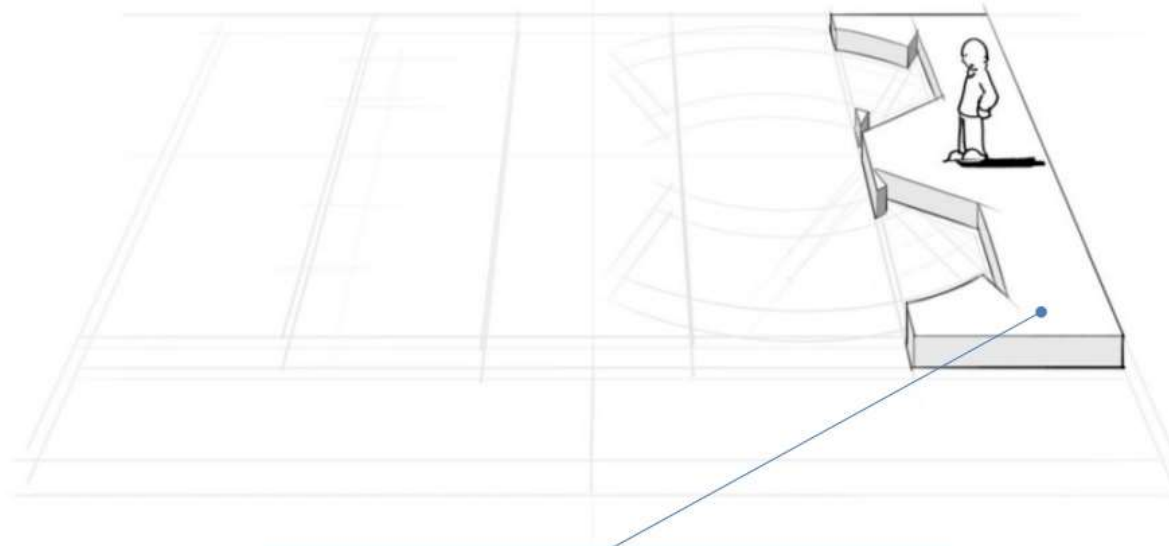

which customers and users are you serving?
which jobs do they really want to get done?

drawings by JAM

10

Value Proposition

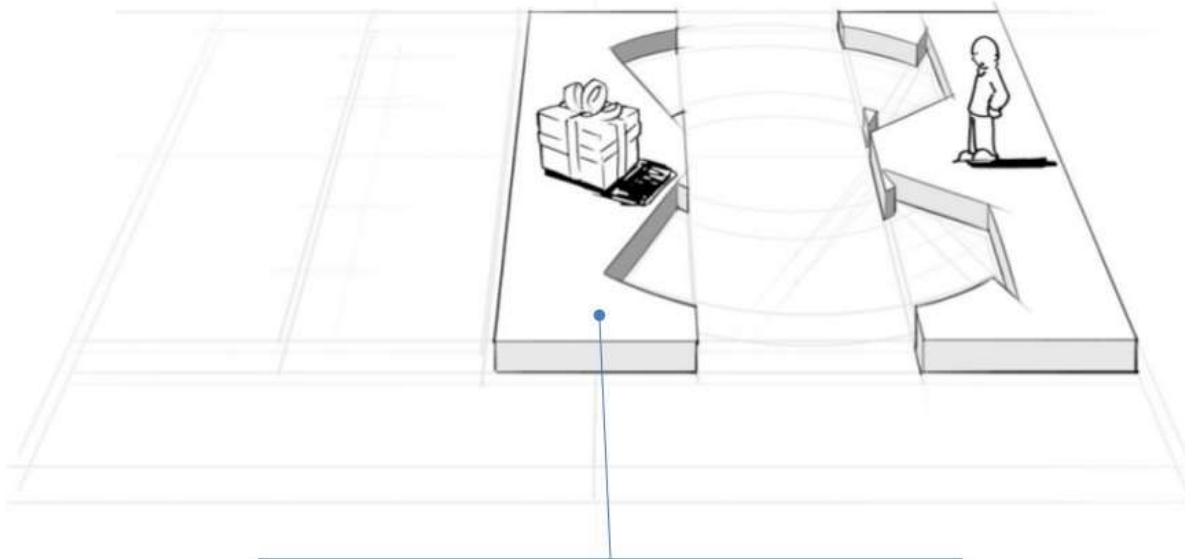

what are you offering them? what is that getting done for them? do they care?

drawings by JAM

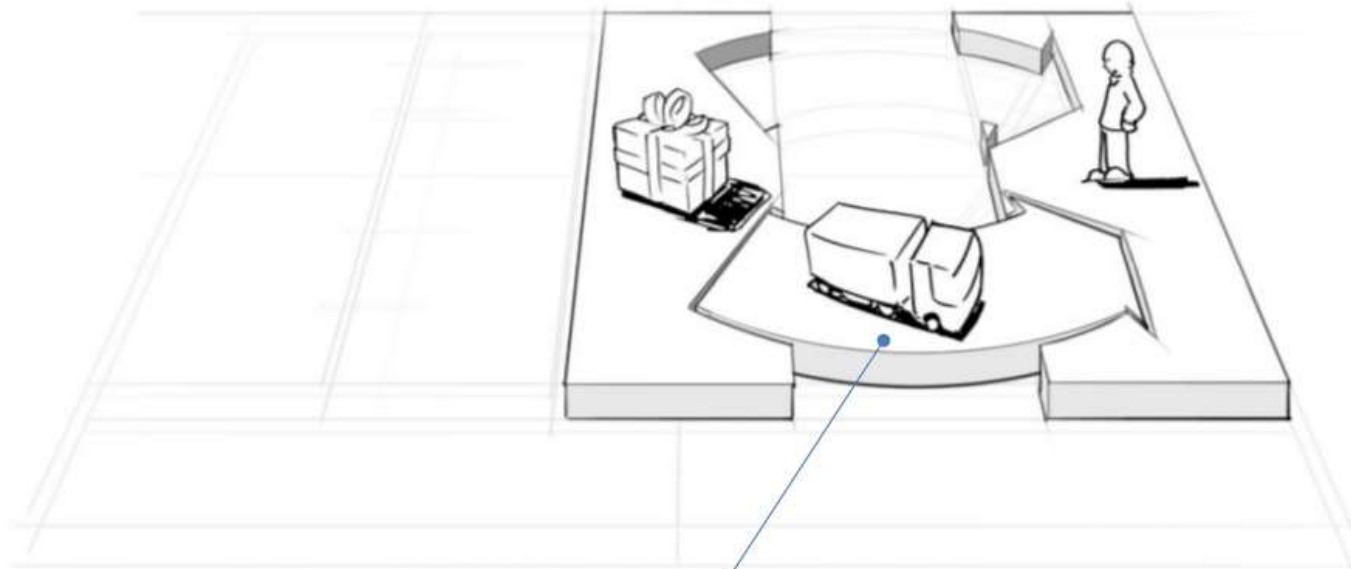

how does each customer segment want to be reached?
through which interaction points?

drawings by JAM

Channels

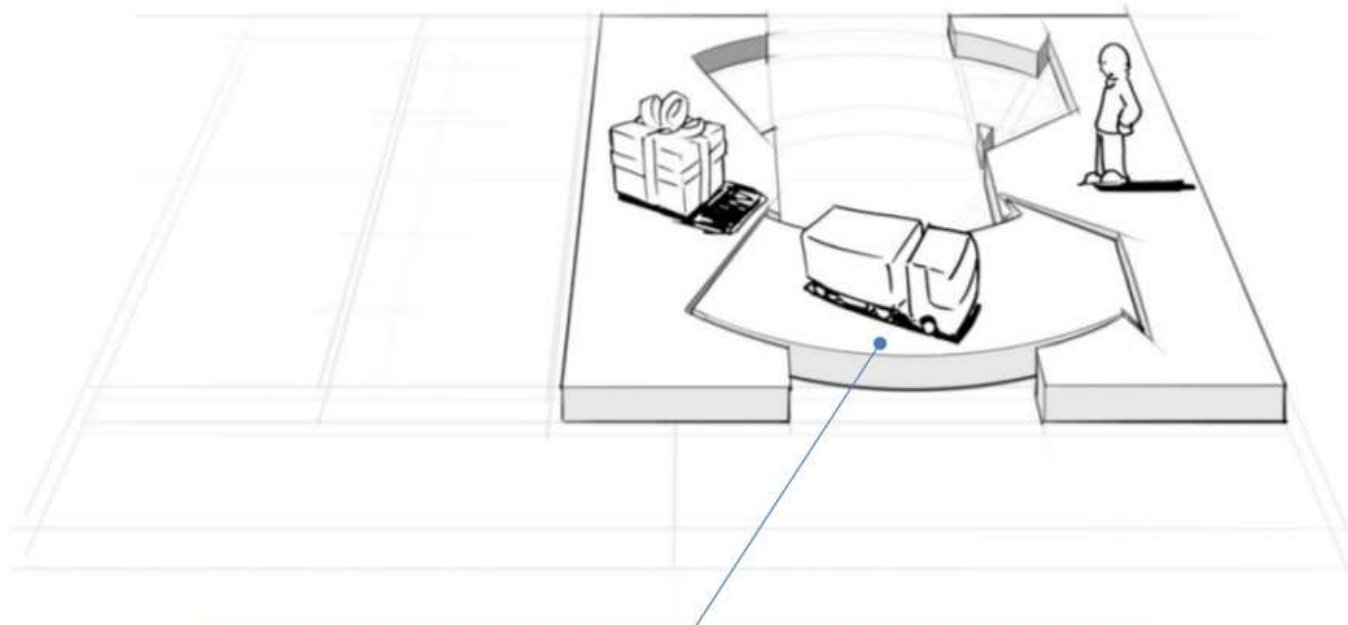

how does each customer segment want to be reached?
through which interaction points?

drawings by JAM

Customer Relationships

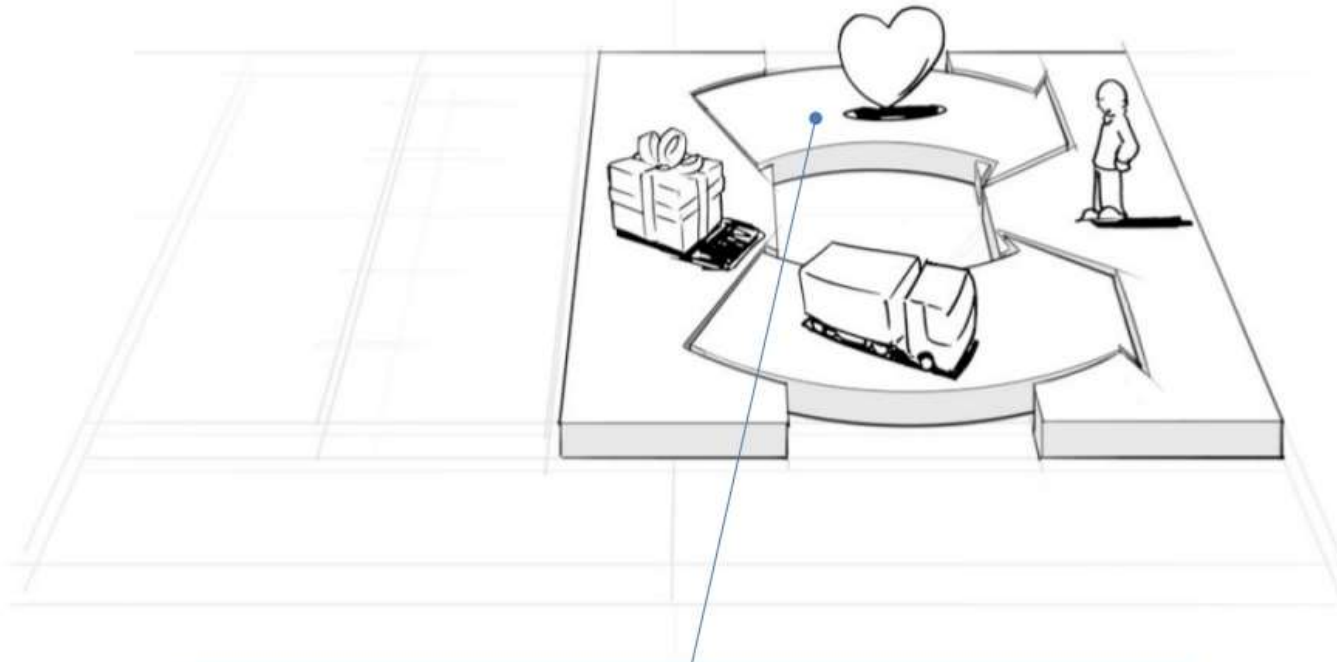

what relationships are you establishing with each segment?
personal? automated? acquisitive? retentive?

drawings by JAM

Revenue Streams

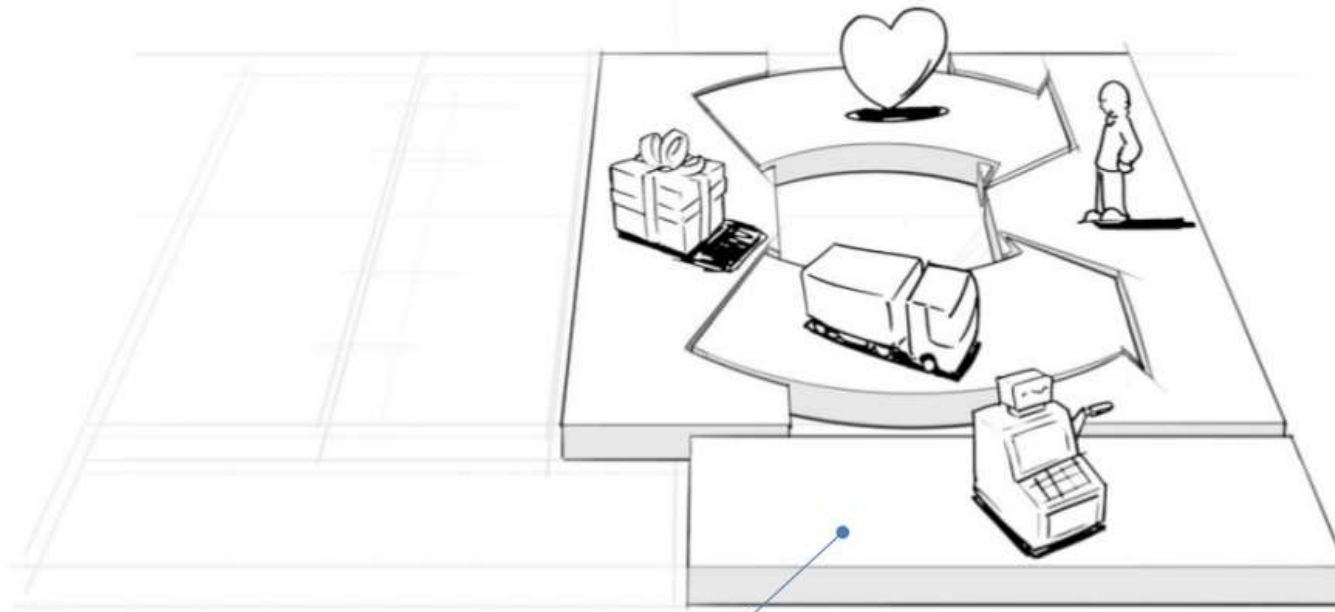

what are customers really willing to pay for? how?
are you generating transactional or recurring revenues?

drawings by JAM

Key Resources

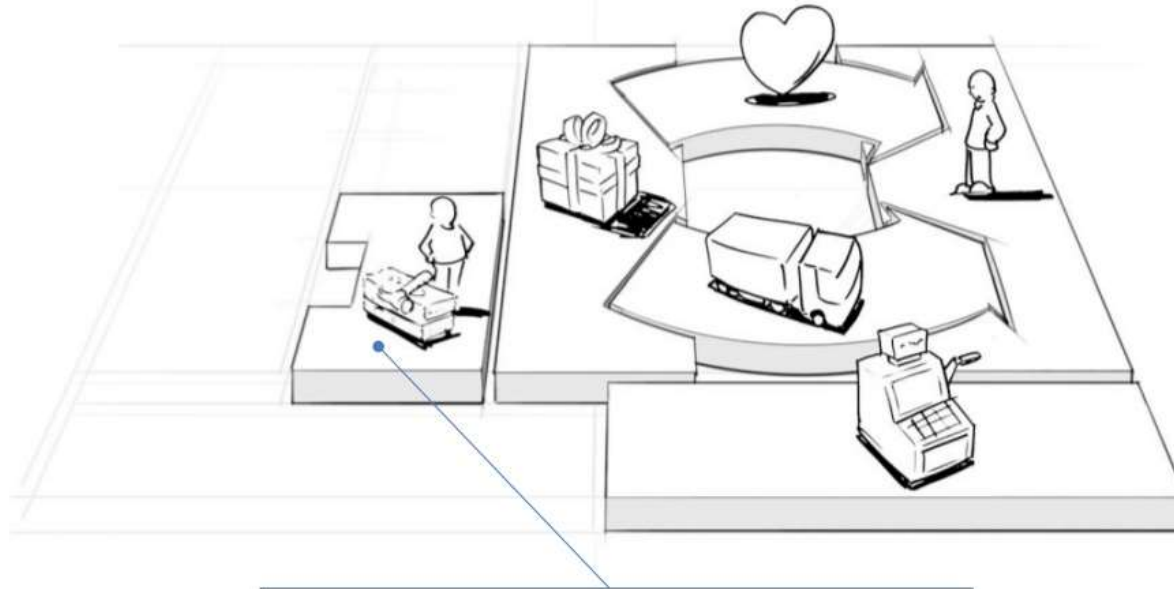

which resources underpin your business model?
which assets are essential?

drawings by JAM

Key Activities

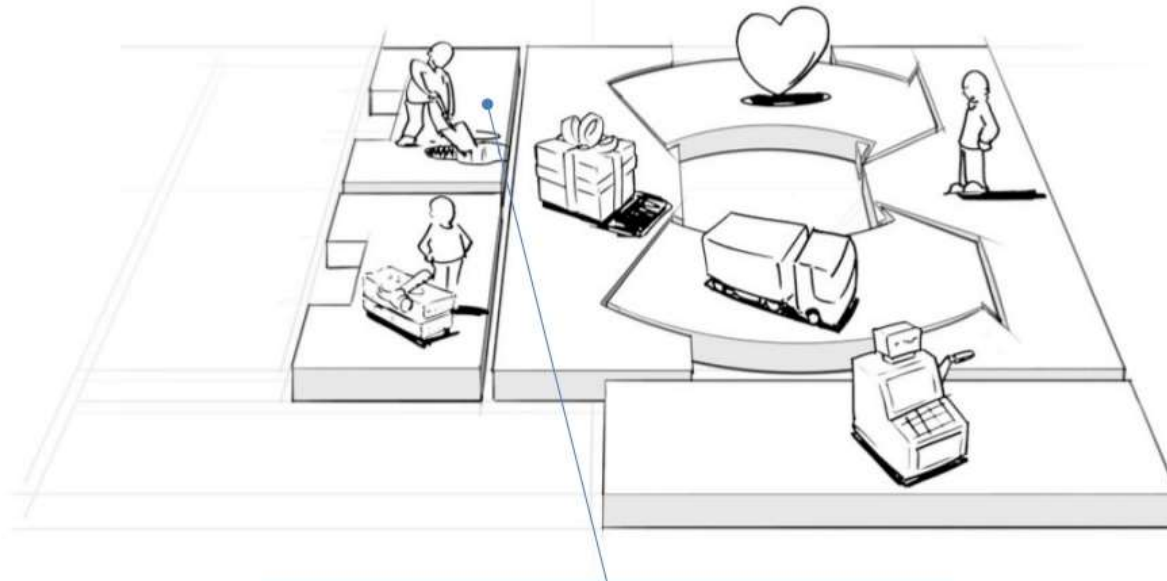

which activities do you need to perform well in your business model? what is crucial?

drawings by JAM

Key Partners

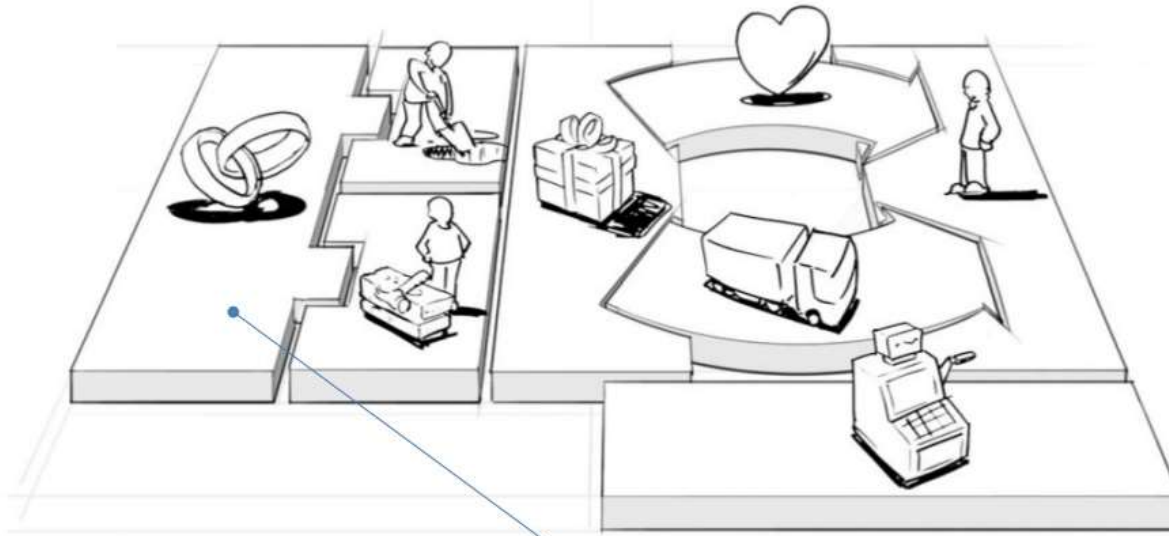

which partners and suppliers leverage your model?
who do you need to rely on?

drawings by JAM

Cost Structure

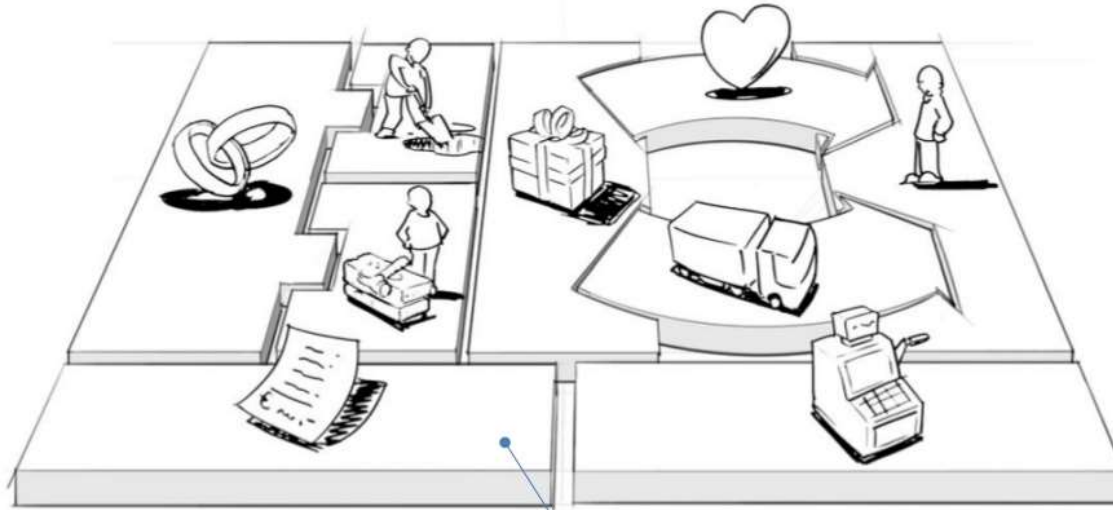

what is the resulting cost structure?
which key elements drive your costs?

drawings by JAM

18

Business Model Canvas

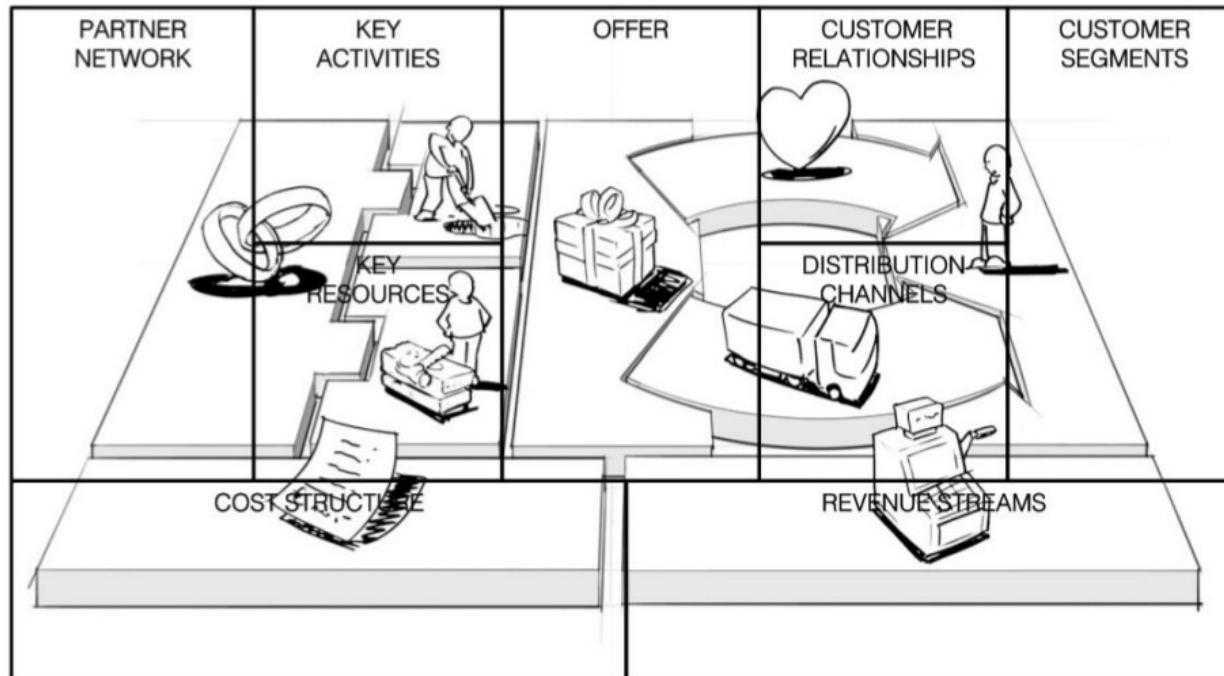

drawings by JAM

The Value Proposition Canvas

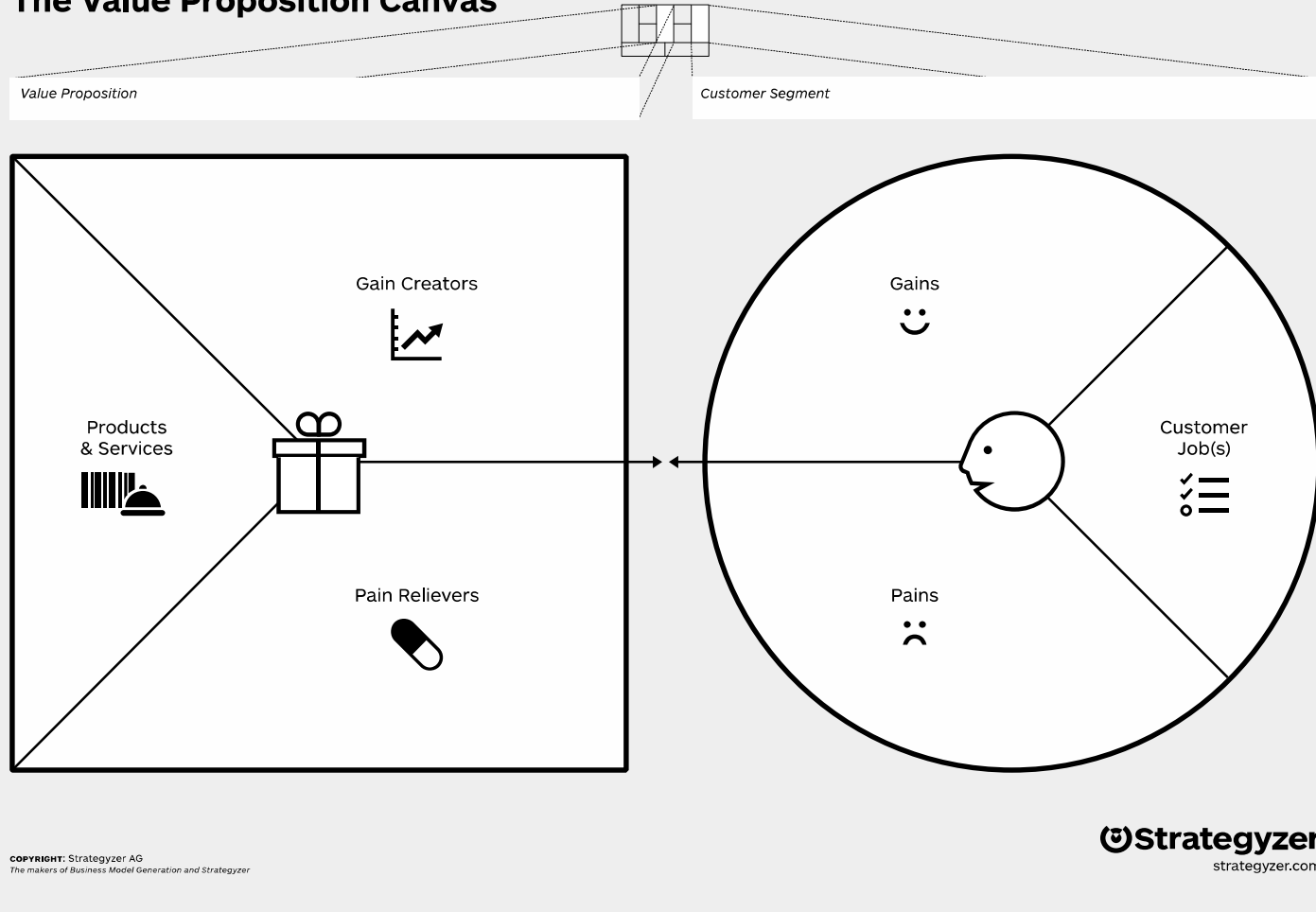

Customer Segments

Key Concepts:

- **Customer Personas**
- **A day in the life**



which customers and users are you serving?
which jobs do they really want to get done?

drawings by JAM

Value Proposition

Key Concept :

**Minimum Viable Product
(MVP)**

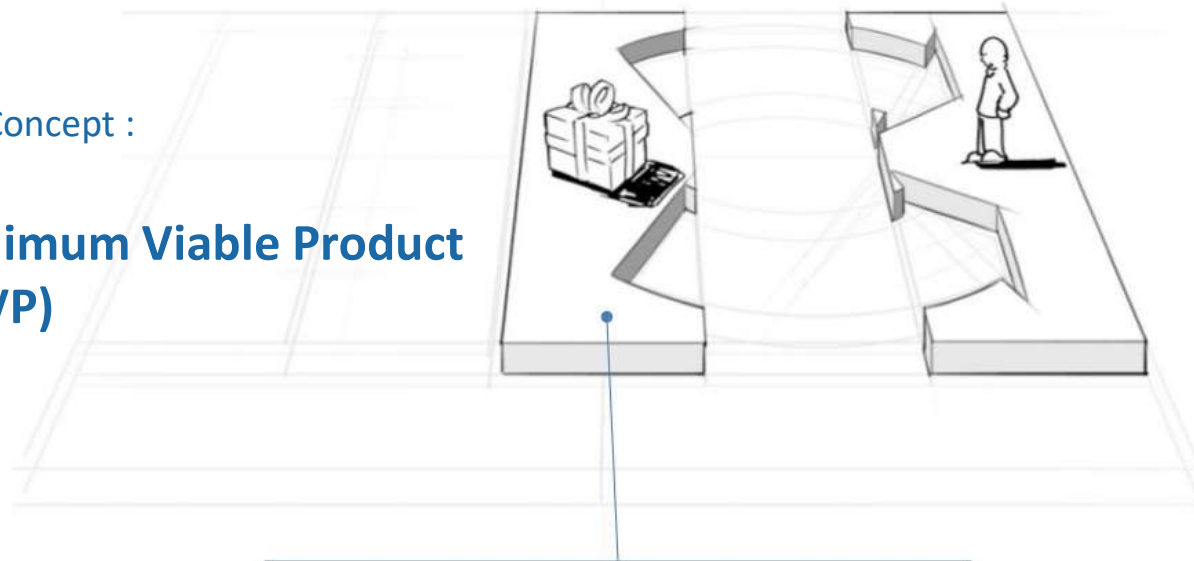

what are you offering them? what is that getting done for them? do they care?

drawings by JAM

Channels

Key Concepts:

- **Touch points**
- **Customer experience**



how does each customer segment want to be reached?
through which interaction points?

drawings by JAM

Exercise – Explain to Your Neighbor

Value Proposition

Key Concept :

**Minimum Viable Product
(MVP)**

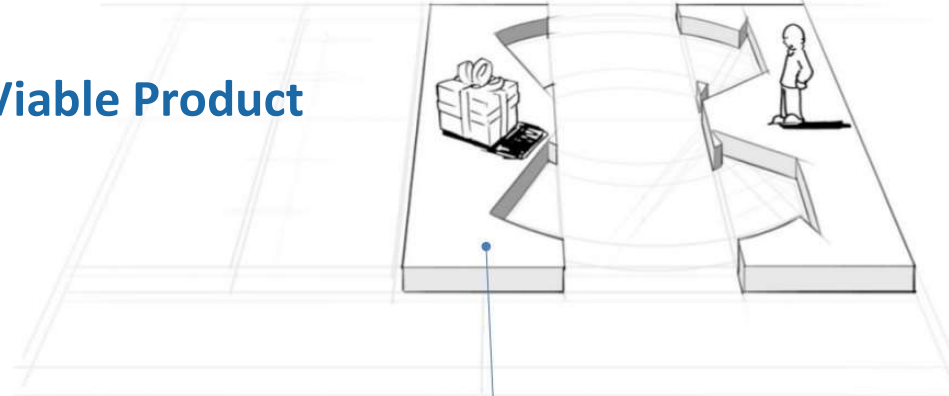

what are you offering them? what is that getting done for them? do they care?

drawings by JAM

11

Exercise – Explain to Your Neighbor Part 2

Customer Relationships

Key Concepts:

- **Get**
- **Keep**
- **Grow**

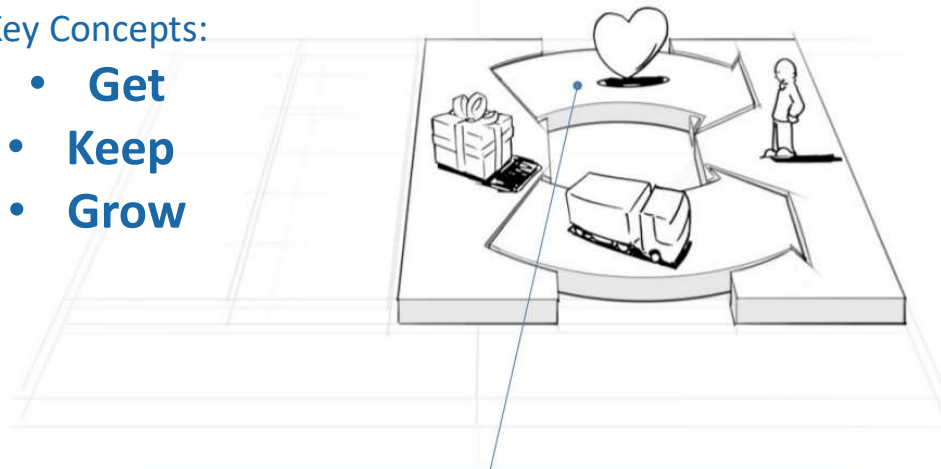

what relationships are you establishing with each segment?
personal? automated? acquisitive? retentive?

drawings by JAM

13

Use of BMC - IT'S NOT LINEAR

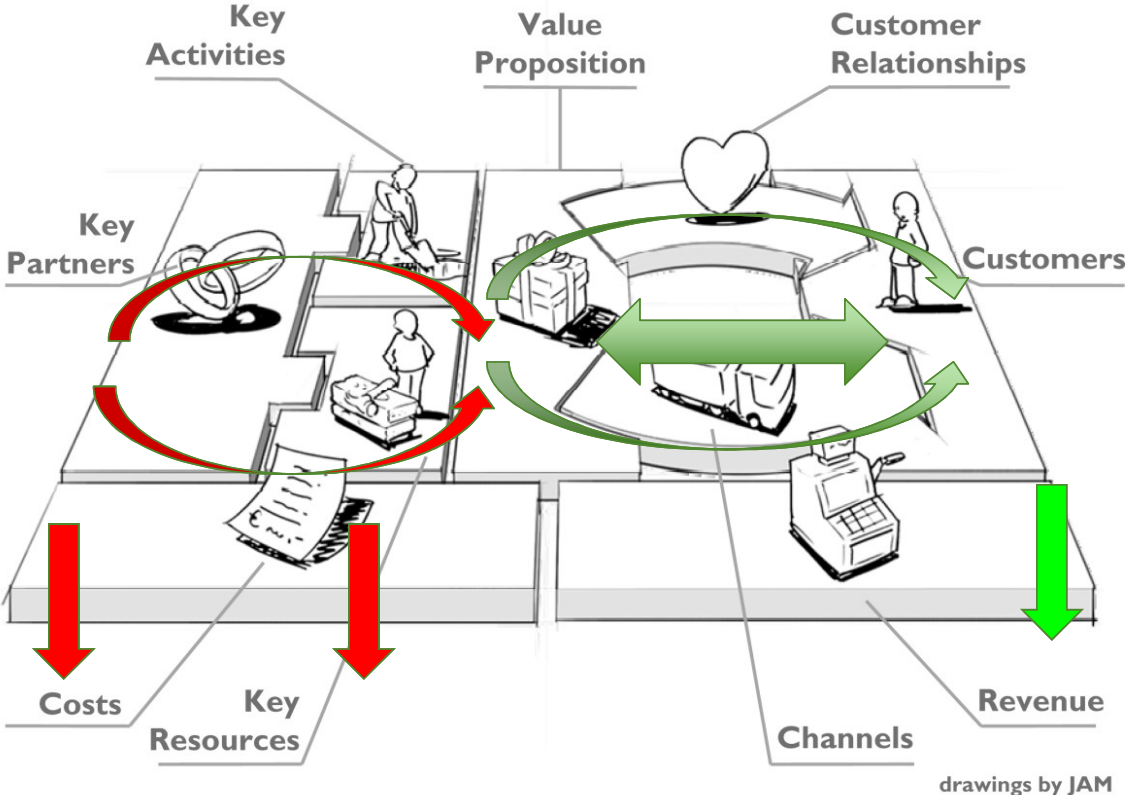

Use of the BMC

Key to success:

**GET
OUT
OF
THE
BUILDING!**

An Example:

GROUPON - Business Model Canvas by Carlo Arioli (English)

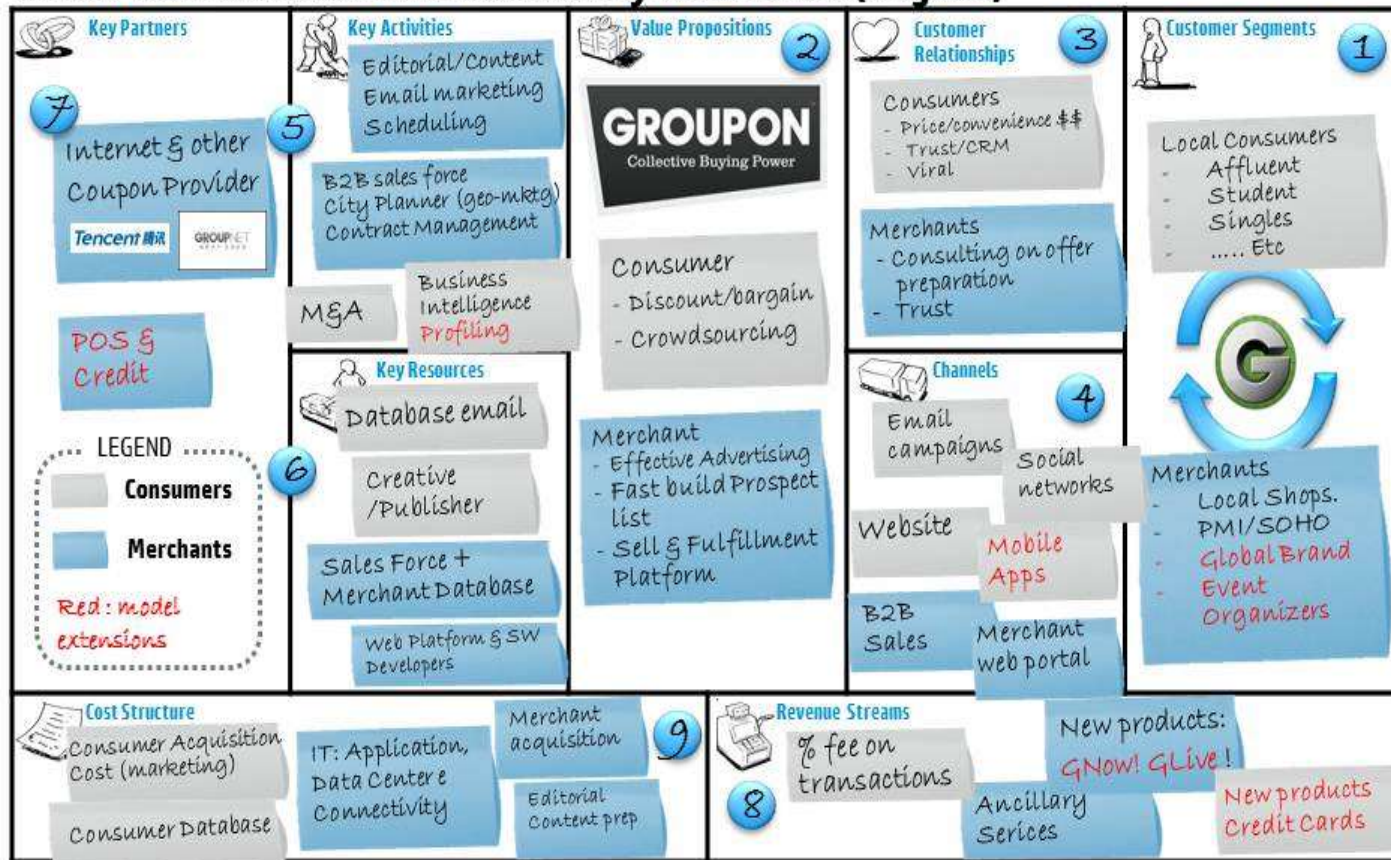

SUMMARY – Doesn't

- The Business Model Canvas (BMC) Is NOT a Business Plan
- It does NOT replace a Business Plan
- It is NOT a shortcut – it still takes work and time and testing
- It is NOT useful in seeking funding

SUMMARY – DOES

The BMC Provides:

- Structure of a business plan without the overhead,
- The improvisation of a ‘back of the napkin” sketch without the fuzziness (and coffee rings).

It IS **MOST USEFUL** in the search for a viable business model for a startup, a growth initiative, and as a diagnostic tool.

Advantages:

- **Focus**
- **Flexibility**
- **Transparency:**

RESOURCES

- Bucks County Score Mentors
- Search on the term “Business Model Canvas” for images
- Search on Slideshare for slide decks
- Books “Business Model Generation” “The Lean Startup”
- Free course on Udacity
www.udacity.com/course/how-to-build-a-startup--ep245
- Email me – dgoeltz@comcast.net

The slides today
are cheerfully borrowed from

- www.Strategizer.com
- www.alexandercowan.com/business-model-canvas-templates/
- <https://www.slideshare.net/esaife/business-model-canvas-101>
- <http://www.marketingespresso.net/groupon-bm/>
- https://hbr.org/resources/images/article_assets/2013/10/canvas1.gif

Handout - Summary Chart with Questions

<p>KEY PARTNERS</p> <p>Who are our key partners? Who are our key suppliers? Which key resources are we acquiring from our partners? Which key activities do partners perform?</p>	<p>KEY ACTIVITIES</p> <p>What key activities do our value propositions require? Our distribution channels? Customer relationships? Revenue streams?</p>	<p>VALUE PROPOSITIONS</p> <p>What value do we deliver to the customer? Which one of our customers' problems are we helping to solve? What bundles of products and services are we offering to each segment? Which customer needs are we satisfying? What is the minimum viable product?</p>	<p>CUSTOMER RELATIONSHIPS</p> <p>How do we get, keep, and grow customers? Which customer relationships have we established? How are they integrated with the rest of our business model? How costly are they?</p>	<p>CUSTOMER SEGMENTS</p> <p>For whom are we creating value? Who are our most important customers? What are the customer archetypes?</p>
<p>KEY RESOURCES</p> <p>What key resources do our value propositions require? Our distribution channels? Customer relationships? Revenue streams?</p>			<p>CHANNELS</p> <p>Through which channels do our customer segments want to be reached? How do other companies reach them now? Which ones work best? Which ones are most cost-efficient? How are we integrating them with customer routines?</p>	
<p>COST STRUCTURE</p> <p>What are the most important costs inherent to our business model? Which key resources are most expensive? Which key activities are most expensive?</p>		<p>REVENUE STREAMS</p> <p>For what value are our customers really willing to pay? For what do they currently pay? What is the revenue model? What are the pricing tactics?</p>		

The Business Model Canvas

QUESTIONS?

Legal Business Entities Options

!!!DISCLAIMER!!!

Please consult your tax professional before making any decisions regarding entity formation

Common Types of Entities

- **Sole Proprietorship**
- **Limited Liability Company (LLC)**
- **Partnership**
 - **General Partnership (GP)**
 - **Limited Partnership (LP)**
 - **Limited Liability Partnership (LLP)**
- **Corporation**
 - **C-Corp**
 - **S-Corp**

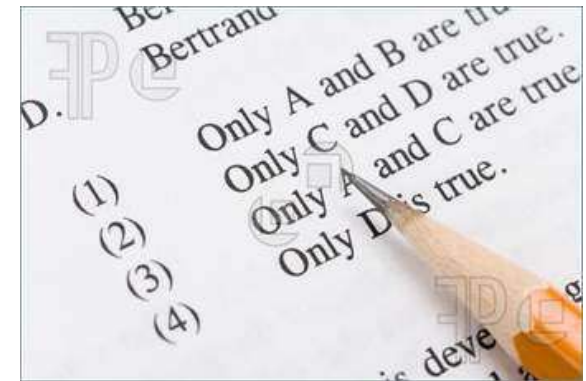

Key Terms to Note

“Limited Liability” –

- *Provides with some degree of protection against their personal liability.*
- *This liability protection is not absolute.*

“Pass Through” – *income tax consequences are passed through to the owners*

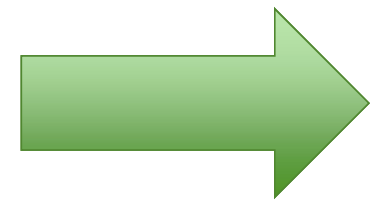

Sole Proprietorship

- Exclusively for a one-person operation
- Income and losses are taxed on the individual's personal income tax return
- The simplest business form
- Not actually a legal entity
- Can operate under the name of its owner or it can do business under a fictitious name,



Limited Liability Company

- **The entity can be owned by one or more members**
 - Members may be individuals or other entities
 - No maximum number
- **An LLC is a limited liability entity like a corporation but is usually a pass through entity for income tax purposes, like a partnership**

HOWEVER:

- Owner must be careful to maintain separation between company/personal assets and activities
- Illegal activity is NOT protected by LLC formation
- **If both limited liability and pass through tax treatment are desired, the LLC is the entity of choice.**
- Formed by filing a Certificate of Organization with the Pennsylvania Corporation Bureau



Limited Liability Company

Pros:

- Can have one or many “members,”
- Members can be individuals or other businesses
- no limit to the number of members
- shield personal assets from business liability
- Pass-through entity for taxes
- Can be managed by Members or non-Members
- Cheap and easy to form in PA (\$125)

Cons

- Limitation on liability can be limited
 - “Pierce corporate veil”
- Self-employment tax

Partnership

- **All items of income, gain, loss, deduction, and credit will be allocated in accordance with the partnership/operating agreement**
- **Otherwise, allocations will be made in accordance with the members' interest in the partnership**
- **Three types:**
 - General Partnership (GP)
 - Limited Partnership (LP)
 - Limited Liability Partnership (LLP)



Corporation

- A corporation is a distinct legal “person”
 - It pays its own taxes
 - It can be sued in its own name
 - It contracts in its own name
- Corporations pay their own taxes and shareholders pay a second tax on dividends
 - A "C" Corporation is a limited liability entity but is not a pass through entity for tax purposes
 - An "S" Corporation is like a "C" Corp - it is a pass through entity for income tax purposes

Any Questions?

Nuts and Bolts



Basics of Getting Started

Get Your Company Established

Choose your company name

- **Make it memorable, but...**
 - Easy to pronounce and remember
 - Avoid unusual spellings
- **Maybe give a clue**
 - Make it pertain to what you do or offer (most times)
- **Don't box yourself in**
- **Verify that it is available**
 - <https://www.pa.gov/guides/starting-a-business/> (scroll down to
 - <https://www.corporations.pa.gov/search/corpsearch>
- **Obtain an appropriate domain name**
 - **Everyone** will assume your company name is domain name minus suffix “.com” .
 - <https://www.thesitewizard.com/archive/registerdomain.shtml>

Get Your Company Established, con't

Register your business structure.

- To operate in Pennsylvania, businesses must register their business structure
- 1 exception - Sole proprietorships operating under the owner's Legal Name (first and last name)

Register your fictitious name.

If you are planning to operate your business under a Fictitious Name, make sure to complete

Register for state tax and employer accounts.

Pennsylvania Business Taxes — including Sales, Use, and Hotel Occupancy Tax, Employer Withholding Tax, and Unemployment Compensation Tax Account Registrations Pennsylvania Department of Revenue
<https://www.pa100.state.pa.us/Registration.htm>

Check with the local municipality concerning taxes, zoning requirements, local licenses and permits, etc.

Confirm that your professional licensure is current

Obtain your Federal Employer Identification Number (FEIN)

<https://www.irs.gov/businesses/small-businesses-self-employed/apply-for-an-employer-identification-number-ein-online>

score.org

Fiscal Matters



Fiscal Matters

- Open a company bank account
- Open a state sales tax account
- Comply with all pertinent state, county, and local licensing requirements, e.g., business license
- Comply with all pertinent Federal, state, county, and local laws and regulations
- Obtain the right type and amount of insurance
- Use a bookkeeper or accountant, attorney, banker, and insurance broker
- Implement business management software



FINANCIAL PLANNING – WHY?



- Essential to determining the capital required to fund operations of a new business during the critical startup period.
- Enables the business owner to effectively allocate funds during the startup period
- Serves as a benchmark to gauge financial performance during the startup period and beyond and make timely adjustments
- A well documented financial plan is necessary to attract potential lenders and/or equity investors

Cash Flow Projection



- **Financial tool:** projects monthly cash inflows (sales revenue) and cash outflows (variable + fixed expenses) –
“ Business blood flow”
- **Negative cash flow:** When cash outflows exceed cash inflows; a normal condition during early months of operation
- **Positive cash flow:** When cash inflows exceed cash outflows. Usually attained after approximately 6-9 months of operation

Cash Flow – Key Considerations



- **Startup capital:** Must provide sufficient cash to fund the business through the breakeven point.
- **Sales forecast:** Must be supported by well thought out assumptions (devise multiple scenarios)
- **Cost assumptions:** Operating assumptions must be well researched
- **Cash cushion:** Plan a cash cushion in the event that sales are slow to materialize or operating costs exceed original estimates
- **Cash “dry up”:** Unable to meet financial obligations - potential bankruptcy

Personal Considerations



Personal Considerations

Is your significant other on board with your decision?

Start-up businesses require:

- Long hours
- Financial belt-tightening
- Personal and financial commitment
- A degree of risk and apprehension

THE STRESS OF A BUSINESS START-UP CAN TEST RELATIONSHIPS!

Personal Finances

- Are your personal finances in order?
- Have you made a personal budget?
- Is your credit score at a desirable level?
- Can you manage your debt?
- Have you set aside a “nest egg” to get you through the start-up period?



Any Questions?

